

Spectrophotometer **CM-26dG** **CM-26d** **CM-25d**

En **Instruction Manual**



Please read before using the instrument.



KONICA MINOLTA



■ Notification for California Customers

Perchlorate Material - Special handling may apply,
see www.dtsc.ca.gov/hazardouswaste/perchlorate.

Official names for applications and the like used in this manual

(Designation in this manual) (Official name)

Bluetooth Bluetooth®

Trademarks

- The Bluetooth® mark and logo are registered trademarks of The Bluetooth SIG, Inc. and are used under license.
- The KONICA MINOLTA logo and symbol marks and SpectraMagic are registered trademarks of KONICA MINOLTA, Inc.

■ Safety Symbols

The following symbols are used in this manual and on the product to prevent accidents that may occur because of incorrect use of the instrument.



**Denotes an instruction regarding a safety warning or note.
Read the instruction carefully to ensure safe and correct use.**



**Denotes a prohibited operation.
This operation must never be performed.**



**Denotes an instruction.
This instruction must be strictly adhered to.**



**Denotes an instruction.
Be sure to disconnect the plug from the outlet.**



**Denotes a prohibited operation.
Never disassemble the instrument.**



This symbol indicates alternating current (AC).



This symbol indicates direct current (DC).

















This symbol indicates class II protection against electric shock.







Notes on this Manual









- Copying or reproduction of all or part of the contents of this manual without the permission of KONICA MINOLTA is strictly prohibited.
- The contents of this manual are subject to change without prior notice.
- Every effort has been made in the preparation of this manual to ensure the accuracy of its contents. However, should you have any questions or find any errors, please contact your retailer or a **KONICA MINOLTA-authorized service facility**.
- KONICA MINOLTA will not accept any responsibility for consequences arising from the use of the instrument.

Safety Precautions

To ensure correct use of this instrument, read the following points carefully and adhere to them. After you have read this manual, keep it in a safe place where it can be referred to anytime a question arises.

	WARNING (Failure to adhere to the following points may result in death or serious injury.)
	Do not use the instrument in places where flammable or combustible gases (gasoline, etc.) are present. Doing so may cause a fire.
	Be sure to turn the instrument OFF in areas where use is prohibited, such as in airplanes or hospitals. Using the instrument in such areas may affect the electronics and medical equipment, which may cause an accident.
	Always use the AC adapter (AC-A305J/L/M) supplied as a standard accessory, and connect it to a 100-240 V ~ (50/60 Hz) AC outlet of the rated voltage and frequency. If an AC adapter other than those specified by KONICA MINOLTA is used, or if the adapter is connected to an unsupported voltage, it may result in damage to the adapter, fire, or electric shock.
	If the instrument will not be used for a long time, disconnect the AC adapter power plug from the AC outlet. Accumulated dirt or water on the prongs of the AC adapter's plug may cause a fire. Clean off any dirt or water on the prongs of the AC adapter's plug before use.
	Do not insert or disconnect the AC adapter plug with wet hands. Doing so may cause electric shock.
	Do not disassemble or modify the instrument or the AC adapter. Doing so may cause a fire or electric shock.
	The instrument should not be operated if it or the AC adapter is damaged, or if smoke or odd smells occur. Doing so may cause a fire. In such situations, turn the power OFF immediately, disconnect the AC adapter plug from the AC outlet, remove the battery, and contact the nearest KONICA MINOLTA-authorized service facility.
	Take special care not to allow liquid or metal objects to enter the instrument and the AC adapter. Doing so may cause a fire or electric shock. Should liquid or metal objects enter the instrument, turn the power OFF immediately, disconnect the AC adapter power plug from the AC outlet, remove the battery, and contact the nearest KONICA MINOLTA-authorized service facility.
	Do not forcibly bend, twist, or pull the cords or cables. Also, do not scratch, fabricate, or place heavy objects on the cables. Doing so may damage the cable and cause a fire or electric shock.
	Firmly push the AC adapter power plug completely into the outlet. Incomplete insertion may cause fire or electric shock.
	Do not dispose of the battery in a fire or short-circuit, heat, or disassemble the battery. Doing so may cause the battery to rupture or leak, which could result in fire or injury.
	In the event that a battery leaks and the fluid comes into contact with the eyes, do not rub the eye. Wash it with clean water, and then immediately consult a doctor. If the leaked fluid comes into contact with skin or clothing, immediately rinse with water. In addition, stop using the instrument if the battery has leaked.
	Use the dedicated charger (CM-A237) to charge the lithium-ion battery. If charging conditions or a charger different from that specified is used for charging, the battery may leak, overheat, or catch fire.
	When disposing of the lithium-ion battery used in this instrument, use tape or some other material to electrically insulate the contacts. Contact with other metals may cause the lithium-ion battery to overheat, rupture, or catch fire. Properly dispose of the lithium-ion battery according to local regulations or recycle the lithium-ion battery.

	Do not touch the battery with wet hands. Doing so may result in electric shock or a malfunction.
	Do not use, charge, or store the lithium-ion battery in a high-temperature environment. Doing so may cause the battery to overheat, catch fire, or rupture.
	Do not throw or submit the lithium-ion battery to strong impacts such as from a fall from a high location. If the lithium-ion battery is deformed or if the built-in protection system is broken, an abnormal current or voltage may be applied to the battery during charging, which may cause the battery to overheat, rupture, or catch fire.
	Do not step on the lithium-ion battery or pierce with a nail or hit with a hammer. If the lithium-ion battery is deformed or if the protection system is damaged, the battery may overheat, rupture, or catch fire.
	Should an unusual odor, heat, discoloration, deformation, or other previously unnoticed abnormality occur during use, charging, or storage, remove the battery from the instrument or charger and discontinue use. Continued use of a battery in this condition may cause the battery to overheat, rupture, or catch fire.
	If the lithium-ion battery is found to be leaking or emitting an unusual odor, keep the battery away from any open flames. The electrolytic solution from the battery may catch fire, causing rupture or fire.
	Do not look directly at the lamp. The lamp is extremely bright and emits ultraviolet rays. Looking directly at the light may injure the eyes.

	CAUTION (Failure to adhere to the following points may result in injury or damage to the instrument or other property.)
	Do not place the instrument on an unstable or sloping surface. Doing so may result in the instrument dropping or overturning, causing injury. Be careful not to drop the instrument when carrying it as well.
	Take care not to pinch yourself on the areas of the instrument that open and close. Doing so may result in injury.
	Do not use the instrument if the specimen measuring port (measurement area) is in the line of sight. Doing so may result in injury to the eye.
	Take sufficient care when handling the target mask with glass. The glass of the target mask may become cracked, resulting in injury. Also, when using a target mask with glass, be sure to use the wrist strap correctly when using the instrument.
	When using the AC adapter, make sure, that an AC outlet is located near the instrument, and that the AC adapter plug can be connected to and disconnected from the AC outlet easily.
	When cleaning the instrument, unplug the AC adapter plug from the outlet. Failure to do so may result in electric shock.
	Do not use any battery other than that specified for use with the instrument. When inserting a battery into the instrument, be sure to insert the battery correctly according to the polarity (positive +, negative -) display on the instrument. Fire, injury, or stains on surroundings may occur if the battery is damaged or leaking.
	Do not use a wet lithium-ion battery. Doing so may cause the battery to rupture or overheat, which could result in fire or injury.

Introduction

The CM-26d and CM-25d are spectrophotometers capable of measuring color and color differences in one measurement for use in a variety of industrial fields. Meanwhile, the CM-26dG is capable of measuring gloss in addition to color and color differences at the same time.

Packing materials of the product

Be sure to keep all packing materials used for shipping the instrument (cardboard box, cushioning material, plastic bags, etc.). This instrument is a precision measuring instrument. When transporting the instrument to a service facility for maintenance or for other reasons, be sure to use the packing materials to minimize shock or vibration. If the packing materials are lost or damaged, contact a **KONICA MINOLTA-authorized service facility**.

■ Notes on Use

Be sure to use this instrument properly. Use of this instrument in ways other than those specified in this manual may result in risk of injury, electric shock, instrument damage, or other problems.

Operating Environment

- The AC adapter supplied as a standard accessory (AC-A305J/L/M) has been designed exclusively for indoor use. Outdoor use is prohibited.
- This instrument is composed of precision electronic components. Never disassemble the instrument.
- Always use the AC adapter supplied as a standard accessory (AC-A305J/L/M) and connect it to a 100 to 240 V \sim (50/60 Hz) AC outlet. Use an AC power supply of the rated voltage (within $\pm 10\%$).
- This instrument is a pollution level 2 product (equipment to be used primarily in manufacturing environments, laboratories, warehouses, and similar locations). This instrument should be used in environments where exposure to metallic dust or condensation is not a concern.
- This instrument is an overvoltage category I product (equipment for connection to circuits in which measures are taken to limit transient overvoltage to an appropriately low level).
- Take care to prevent foreign matter from entering the instrument. Using the instrument while subjected to intrusion of water or metals is extremely dangerous.
- Using the instrument in direct sunlight or near heating equipment can cause the internal temperature of the instrument to become much higher than the ambient temperature, resulting in malfunction. Do not use the instrument in such areas.
- Avoid subjecting the instrument to sudden temperature changes and condensation.
- Do not use the instrument in areas where dust, smoke, or chemical gases are present, or in extremely humid environments.
- This instrument should be used in an environment with an ambient temperature between 5°C and 40°C and maximum relative humidity 80% for temperatures up to 35°C decreasing linearly to 62% relative humidity at 40°C with no condensation. Use of the instrument outside this range will result in unsatisfactory performance.
- Do not use the instrument at altitudes higher than 2,000 m.
- Do not use the instrument near equipment that produces a strong magnetic field (such as speakers).
- This instrument complies with Electrical equipment for measurement, control and laboratory use - EMC(Electromagnetic Compatibility) requirements - Part 1: General requirements (EU Harmonized Standards EN 61326-1:2021). Conformity verification is performed under KONICA MINOLTA's test conditions in an INDUSTRIAL ELECTROMAGNETIC ENVIRONMENT specified in the relevant harmonized standards. The limit of performance degradation when subjected to continuous disturbance during immunity testing is up to twice KONICA MINOLTA's repeatability specifications (ΔE^*ab , GU). (GU:CM-26dG only)
- To secure the instrument for use, make sure the instrument is firmly attached with no possibility of falling off. Failure to do so may result in harm to the instrument or people and objects around the instrument.

System

- Do not subject the instrument to strong vibrations or impacts.
- Do not pull, forcibly bend, or apply excessive force to the connected cables and cords. Doing so may cause the cable or cord to break.
- Do not allow the specimen measuring port of the instrument to become dirty or subject the aperture to impact. Place the instrument on the calibration stage when not in use.
- If the instrument is exposed to strong external static electricity, the LCD may go blank or fail to display information correctly. Communication with a connected external device may also be interrupted. In such cases, turn the power OFF and then ON again. If black smudges appear on the LCD, wait until they disappear naturally.

- When turning the power OFF and then ON again, wait several seconds after turning the power OFF before turning the power ON again.
- The instrument should be connected to a power source with as little noise as possible.
- When a malfunction or abnormal behavior occurs, turn the power OFF immediately, disconnect the AC adapter plug from the AC outlet, and refer to P.149 "Troubleshooting".
- Should the instrument break down, do not try to disassemble and repair the instrument. Contact a **KONICA MINOLTA-authorized service facility**.

Backup Battery

- Various settings are stored in the instrument's built-in battery-powered backup memory. The backup battery will be charged when the instrument is powered or when the lithium-ion battery is being charged, regardless of whether the power switch is turned ON/OFF. The backup battery takes 20 hours to become fully charged, and there is no danger of overcharging. At full charge, the backup battery can store data for up to one year. However, the backup battery may not be fully charged when the instrument is purchased. The backup battery will charge as the instrument is being used.
- Do not attempt to replace the built-in backup battery. The battery should only be replaced by KONICA MINOLTA. To replace the backup battery, please contact a **KONICA MINOLTA-authorized service facility**.
- It is recommended to manage important data and settings using the optional SpectraMagic NX2 software.

Calibration Plate

- The calibration data for the calibration plate was measured at 23°C. To achieve the highest accuracy when measuring absolute values, calibration and measurement should be performed at 23°C.
- Do not allow the calibration plate to become scratched or dirty.
- When the calibration plate is not in use, be sure to close the cap so that the plate is not exposed to light.

Power Source

- Make sure that the power is turned OFF when the instrument is not in use.
- This instrument should be used with the lithium-ion battery installed. You cannot use the instrument connected to the AC adapter only.
- Make sure the AC adapter output plug is not short-circuited. Doing so may cause a fire or electric shock.
- Do not connect the AC adapter to an overloaded electrical circuit. In addition, do not wrap or cover the AC adapter with cloth or other material while in use. Doing so may cause an electric shock or fire.
- When removing the AC adapter from the instrument, first remove the power cord from the outlet, and then remove the output plug.

Battery

- Use only the standard accessory lithium-ion battery or the optional accessory lithium-ion battery CM-A235 (RRC1120). Absolutely do not use any other type of battery.
- The battery in the instrument will be charged from the power supplied through the USB cable regardless of whether the instrument is turned ON or OFF.
- The battery is not charged upon purchase and must therefore be charged.
- The battery takes about 6 hours to become fully charged. There is no need to worry about overcharging.
- The lithium-ion battery will self-discharge. The battery will become unusable due to over discharging if left for a long period. Charge the battery for at least one hour using the instrument or an optional battery charger at least semiannually.
- After using up the lithium-ion battery, do not leave it uncharged.
- Charging should be performed at between 5 and 40°C. Charging will not be performed outside this temperature range.
- If the lithium-ion battery will not be used for a long period, remove the battery from the instrument and store it in a location not subject to high temperatures or high humidity.

Introduction (cont.)

■ Notes on Storage

- Storing the instrument in direct sunlight or near heating equipment can cause the internal temperature of the instrument to become much higher than the ambient temperature, resulting in malfunction. Do not store the instrument in such areas.
- This instrument should be stored at a temperature between 0°C and 45°C with a relative humidity of 80% or less (at 35°C) and no condensation. Storing the instrument in an environment with high temperatures and high humidity will result in unsatisfactory performance. Storing the instrument together with the drying agent at or near room temperature is recommended.
- Make sure that the instrument is not subjected to condensation when stored. In addition, take care to prevent rapid temperature changes to prevent condensation from occurring when transporting the instrument to the storage location.
- Do not store the instrument in areas where dust, smoke, or chemical gases are present. Doing so may cause deterioration in performance or a malfunction.
- Do not leave the instrument inside the cab or trunk of a vehicle. Otherwise, the temperature and/or humidity may exceed the allowable range for storage, resulting in a malfunction.
- Dust inside the specimen measuring port may prevent accurate measurements from being performed. When the instrument is not in use, cover the measuring port to prevent the intrusion of dust and the like.
- The calibration plate may become discolored if left exposed to light. Therefore, make sure to close the cap when the plate is not in use in order to prevent the plate from being exposed to light.
- When not in use, store the instrument in the packing used for shipment or in the optional hard case and keep it in a safe place.
- Take care not to pinch yourself on the areas of the protective hard case that open and close. Doing so may cause injury.

■ Notes on Cleaning

- If the instrument becomes dirty, wipe it with a soft, dry cloth. Never use organic solvents (such as naphtha or thinner) or other chemicals for cleaning.
- If there is dust or dirt on the lens or the receptor window, use a blower or the like to blow it off. Never use organic solvents (such as naphtha or thinner) or other chemicals for cleaning.
- If the calibration plate becomes dirty, gently wipe the dirt off using the supplied cleaning cloth. If the dirt is excessive, wipe with a cleaning cloth slightly moistened with ethanol. If the cleaning cloth is dirty, clean the cloth by washing it.
- If you are unable to remove dirt from the instrument through the above procedure, or if the instrument becomes scratched, **contact a KONICA MINOLTA-authorized service facility.**
- If the specimen measuring port of the instrument becomes dirty, contact a **KONICA MINOLTA-authorized service facility.**

■ Notes on Transporting

- When transporting the instrument, be sure to use the packing materials to minimize shock or vibration.
- When sending the instrument in for service, package and send the instrument and all accessories.

■ Maintenance and Inspection

- To maintain measurement accuracy, the instrument should be inspected once a year. For information on inspection, contact the nearest **KONICA MINOLTA-authorized service facility.**

■ Disposal Method

- Make sure that the instrument, all accessories (including any used batteries), and the packing materials are either disposed of or recycled correctly in accordance with local laws and regulations.
- In the United States and Canada, you can recycle your lithium-ion battery through the Call2Recycle program. For more information, in the United States visit www.call2recycle.org and in Canada visit www.call2recycle.ca.



Table of Contents

Safety Symbols	ii	Calibration.....	35
Notes on this Manual	ii	Zero calibration.....	35
Introduction	3	White Calibration and Gloss Calibration	37
Notes on Use	3	User calibration	39
Notes on Storage	5	Setting a Specimen	40
Notes on Cleaning	5	Viewfinder	40
Notes on Transporting	5	Measurement	41
Maintenance and Inspection.....	5	Displaying the Measurement Results	42
Disposal Method.....	6	<input type="checkbox"/> <Sample> detail screen: Absolute value.....	42
Conventions	9	<input type="checkbox"/> <Sample> detail screen: "Difference" tab...	43
<input type="checkbox"/> Instrument Firmware Version	9	<input type="checkbox"/> <Sample> detail screen: "Abs. & Diff." Tab...	43
		<input type="checkbox"/> <Sample> detail screen: "Pass/Fail" tab	44
		<input type="checkbox"/> <Sample> detail screen: "Custom" tab	44
		<input type="checkbox"/> <Sample> detail screen: "Abs. Graph" Tab...	45
		<input type="checkbox"/> <Sample> detail screen: "Diff. Graph" Tab ...	45
		<input type="checkbox"/> <Sample> detail screen: "Spectral Graph" tab ...	46
		<input type="checkbox"/> <Sample> List Screen	46
		Measurement (Simple Mode).....	48
		Handling the Sample	50
		Print Data (Sample).....	51
		Edit name	52
		Data Management (Sample)	53
		<input type="checkbox"/> Delete	53
		<input type="checkbox"/> Set Sample as Target	54
		<input type="checkbox"/> Change Target Reference	55
		<input type="checkbox"/> Change list position	56
		<input type="checkbox"/> Delete All Data (Sample).....	57
		Auto Target (Sample)	58
		<input type="checkbox"/> Auto Target (Sample).....	58
		<input type="checkbox"/> Threshold (Sample).....	59
		Pass/Fail Judgment for Color Difference.....	60
		Pass/Fail Judgment Based on Tolerances.....	60
		Color Difference Target Operation	62
		Print Data (Target)	63
		Edit name	64
		Data Management (Target)	65
		<input type="checkbox"/> Delete	65
		<input type="checkbox"/> Set group	66
		<input type="checkbox"/> Change list position	67
		<input type="checkbox"/> Edit Target filter.....	68
		<input type="checkbox"/> Data Protection	69
		<input type="checkbox"/> Delete All Data (Target).....	70
		Pass/Fail.....	71
		<input type="checkbox"/> Tolerance Settings.....	72
		<input type="checkbox"/> Tolerance List	73
		<input type="checkbox"/> Warning Level Setting	74
		<input type="checkbox"/> Parametric Coefficient Setting	75
Chapter 1 Before Using the Instrument... 10			
Accessories.....	11		
Standard Accessories.....	11		
Optional Accessories	12		
System Diagram	14		
Names and Functions of Parts	17		
<input type="checkbox"/> Calibration Stage	19		
Cleaning the Components	20		
<input type="checkbox"/> Zero Calibration Hole (Calibration Stage)...	20		
<input type="checkbox"/> White Calibration and Gloss Calibration*			
(* CM-26dG only)	20		
<input type="checkbox"/> Target Mask.....	20		
<input type="checkbox"/> Inside the Integrating Sphere	20		
Points to Remember	21		
Initial Settings.....	21		
Control Panel	21		
<input type="checkbox"/> Display (LCD Screen).....	22		
<input type="checkbox"/> Status bar	23		
<input type="checkbox"/> Operation Keys	24		
Menus	25		
Data Saving	27		
Chapter 2 Measurement 28			
Flow of Measurement	29		
Preparation	30		
<input type="checkbox"/> Attach the Wrist Strap	30		
<input type="checkbox"/> Inserting the Battery	31		
<input type="checkbox"/> Connecting the AC Adapter	32		
<input type="checkbox"/> Turning the Power ON/OFF.....	32		
<input type="checkbox"/> Measurement Area Selection			
(CM-26dG/CM-26d)	33		
<input type="checkbox"/> Target Mask Replacement			
(CM-26d/CM-25d).....	33		
<input type="checkbox"/> Staple-Type Target Mask.....	34		

Input Colorimetric Data	76
<input type="checkbox"/> Color space	76
<input type="checkbox"/> Input Data	77
Default Data Settings	79
<input type="checkbox"/> Tolerance List	80
<input type="checkbox"/> Default Tolerance Setting	81
<input type="checkbox"/> Warning Level Setting	82
<input type="checkbox"/> Parametric Coefficient Setting	83
<input type="checkbox"/> Set group	84

Chapter 3 Setting 86

Measurement Condition Settings.....	87
Measurement Condition Settings.....	87
<input type="checkbox"/> Measurement mode	88
Opacity Measurement	89
Measurement Option Settings	91
<input type="checkbox"/> Specular Component	92
<input type="checkbox"/> UV (100%/0%/100% + 0%/UVC)	93
<input type="checkbox"/> Auto average (1 to 10)	94
<input type="checkbox"/> Manual average (1 to 30)	95
<input type="checkbox"/> SMC Function (Outlier-Free Measurement)	96
<input type="checkbox"/> SMC Threshold	97
<input type="checkbox"/> SMC Times	98
Observation Condition Settings	99
<input type="checkbox"/> Observer/Illuminant 1	100
<input type="checkbox"/> Observer/Illuminant 2	102
Display Settings	103
<input type="checkbox"/> Display type	104
<input type="checkbox"/> Color space	105
<input type="checkbox"/> Color difference equation	106
<input type="checkbox"/> Custom	107
Instrument Settings	108
Measurement Instrument Option Settings	108
<input type="checkbox"/> User type	109
<input type="checkbox"/> Display Language Settings	110
<input type="checkbox"/> Date Format Settings.....	111
<input type="checkbox"/> Clock Settings	112
<input type="checkbox"/> Screen Brightness	113
<input type="checkbox"/> LCD Screen Display Orientation.....	114
<input type="checkbox"/> Beep	115
<input type="checkbox"/> Auto Power Off.....	116
<input type="checkbox"/> Password Setting	117
<input type="checkbox"/> Wake On Mode Settings	118

Chapter 4 Other Functions..... 120

Connecting to an External Device.....	121
◎ Connecting to a Computer.....	121

Connecting via USB Cable	122
Connecting Via Wireless LAN/Bluetooth	123
○ Instrument Preparation	123
• Connecting the WLAN/Bluetooth Module ...	123
Communication Setup (When Using Bluetooth) ...	124
<input type="checkbox"/> Bluetooth Function Settings	124
○ Connecting to a Computer	126
Communication Setup (When Using Wireless LAN Function: Ad Hoc Method)	127
<input type="checkbox"/> Wireless LAN Function: Ad Hoc Method Settings	128
○ Connecting to a Computer	128
Communication Setup (When Using Wireless LAN Function: Infrastructure Method)	129
<input type="checkbox"/> Wireless LAN Function: Infrastructure Method Settings	130
○ Connecting to a Computer	130
◎ Connecting to a Printer/Barcode Reader ...	131
○ Printer/Barcode Reader Preparation	131
Instrument Preparation.....	132
<input type="checkbox"/> Registering a Bluetooth Address	132
<input type="checkbox"/> PIN Code Configuration.....	133
<input type="checkbox"/> Printing Data.....	134
<input type="checkbox"/> Auto Print	135
System Settings.....	137
Calibration setup	137
<input type="checkbox"/> Calibration Interval Messages.....	138
<input type="checkbox"/> Annual Calibration Messages	139
<input type="checkbox"/> User calibration	140
<input type="checkbox"/> Zero calibration skip.....	141
Displaying Diagnosis Info.....	142
Displaying the Instrument Information	143
JOB Function.....	144

Chapter 5 Troubleshooting 146

Message List	147
Troubleshooting	149

Chapter 6 Appendix..... 152

Fluorescence Measurement	153
Specifications	154
Dimensions	156

User Equation and User Class.....UE-1

Conventions

This manual describes how to safely operate CM-26d series products using a specific procedure to perform measurement.

• Viewing Pages

Symbols used in this manual are explained below.

* Explanatory pages are constructed as follows. (The content of the explanatory illustration will differ from the actual page.)

* Display screenshots used in the explanations may include different content and values, and may have a different layout than the actual display.

Procedure

Indicates an operating procedure.

Settings

Describes ranges and provides explanations regarding settings for the screen in question.

Memo

Provides useful information, supplementary explanations, and similar details.

Notes

Provides essential information for correct operation of the instrument. Always read this information before operating the instrument.

Display type

Configure the display type for the measurement results.

Memo All display types are selected when the instrument is shipped from the factory.

Operating Procedure Start the procedure from the <Measurement cond.> - <Display cond.> screen.

1 Use [▲] or [▼] to move the cursor to "Display type", and then press the [Confirmation] key. The <Display type> screen is displayed.

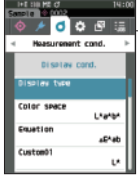

2 Use [▲] or [▼] to move the cursor to the desired display type, and then press the [Confirmation] key.

Settings

- Absolute value: Displays the absolute values of the colorimetric and the gloss values.
- Difference: Displays the color difference and gloss value difference against the target. The measurement that failed the pass/fail judgment based on the tolerance will be highlighted in red.
- Abs. & Diff.: Displays the absolute value and the color difference and gloss value difference against the target. The measurement that failed the pass/fail judgment based on the tolerance will be highlighted in red.
- Pass/Fail: Determines whether the color difference and gloss value difference related to the target are within the tolerance range set in advance. If within the tolerance, the judgment will be displayed as "Pass". If even one difference is not within the tolerance, the judgment will be displayed as "Fail".
- Custom: Displays the display color value and index set under "Custom" as the two illuminants.
- Abs. Graph: Displays a graph of the absolute values of the colorimetric and the gloss values.
- Diff. Graph: Displays a graph showing the color difference and gloss value difference against the target.
- Spectral Graph: Displays a graph showing the spectral reflectance. The [Confirmation] key can be used to move the wavelength displaying the spectral reflectance value.

Memo A check mark means the item is selected.

3 After all settings have been configured, use [▲] or [▼] to move the cursor to "OK", and then press the [Confirmation] key. The selection is confirmed and the screen returns to the previous screen.

Notes If [ESC] is pressed without pressing the [Confirmation] key, the settings will not be changed, and the screen will return to the <Display cond.> screen.

Start screen

Indicates the initial screen from which the operation is commenced.

Screenshot

Indicates the state of the screen when the operation described in the procedure to the left is carried out.

Instrument Firmware Version

The firmware version of the instrument can be viewed on the <Instrument Info> screen. For details, refer to P.143 "Displaying the Instrument Information" in this manual.

Chapter 1

Before Using the Instrument

Accessories.....	11
Standard Accessories.....	11
Optional Accessories	12
System Diagram	14
Names and Functions of Parts	17
Cleaning the Components	20
Points to Remember	21
Initial Settings.....	21
Control Panel	21
Menus	25
Data Saving	27

Accessories

Standard and optional accessories are available with the instrument.

Memo The shape of some products may be different from those shown.

*Not available in all areas.

■ Standard Accessories

AC Adapter AC-A305J/L/M (UBX305)*

Used to supply power from an AC outlet to the instrument.

Input: 100 to 240 V \sim 50/60 Hz 0.15 A

Output: 5 V --- 1 A

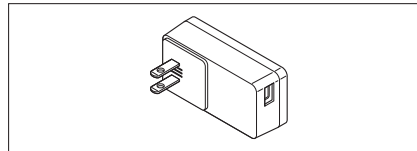

Lithium-Ion Battery CM-A235 (RRC1120)*

- Insert the battery into the instrument, and connect the instrument to the AC adapter or to a computer using the IF-A28 USB cable to charge.
- The battery itself can also be charged using a separately sold charger.

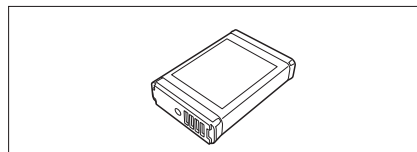

Calibration Stage CM-A274 (for CM-26dG) / CM-A275 (for CM-26d) / CM-A276 (for CM-25d)

Used to perform calibration.

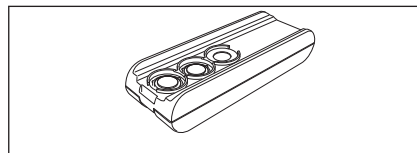

Wrist Strap CR-A73

Used to prevent users from inadvertently dropping the instrument.

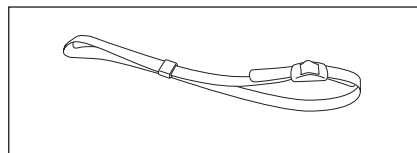

USB Cable (2 m) IF-A28

Used to connect the instrument to a computer.

When using the AC adapter, power will be supplied through the cable.

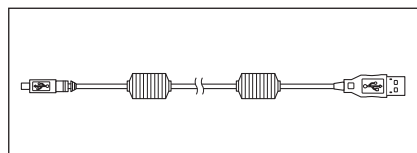

Target Mask

During reflectance measurement with the CM-26d only, attaching an MAV or SAV target mask according to the set measurement area allows users to change the specimen measuring port size according to the specimen.

(Included: ○, Not included: —)

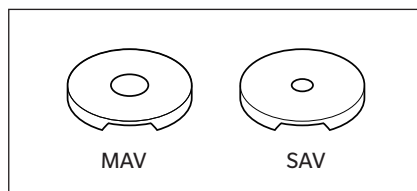

	MAV CM-A272	SAV CM-A273
CM-26dG	—	—
CM-26d	○	○
CM-25d	○	—

Spectrophotometer Configuration Tool CM-CT1

This PC software is used to configure display conditions and other settings as well as writing calibration data to measurement instruments from a computer. Visit <https://www.konicaminolta.jp/instruments/support/download/color/cmct1/install.html> to download the tool for free.

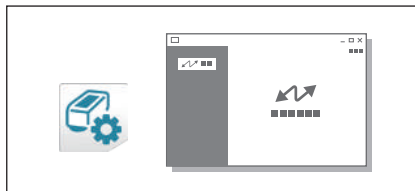

Flat Type Battery Cover CM-A218

Used when the measurement surface of a target specimen is lower than the bottom surface of the instrument.

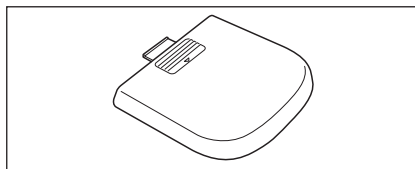

Cleaning Cloth (* CM-26dG only)

Used to clean the calibration plate.

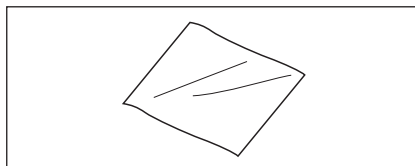

Optional Accessories

Stapler Type Target Mask CM-A268

Used for easily determining the measurement area when performing color measurements.

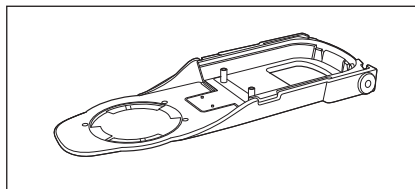

Target Sheet

Used to change the target sheet opening according to the main body target mask diameter. Attach the sheet to the stapler type target mask for use. (Included: ○, Not included: —)

	For gloss CM-A269	MAV (Ø8 mm) CM-A270	SAV (Ø3 mm) CM-A271
CM-26dG	○	—	—
CM-26d	—	○	○
CM-25d	—	○	—

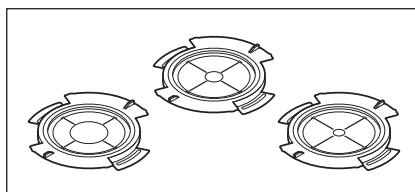

Hard Case CM-A267

Used for transporting the instrument and accessories.

Memo May be included as a standard accessory in some regions.

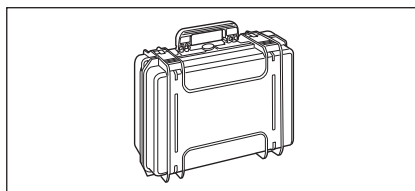

Target Mask (MAV; w/ glass) CM-A277

Used to protect the inside of the specimen measuring port when measuring in direct contact with powders or in an environment where the inside of the specimen measuring port may be affected by dust or liquid.

Memo Cannot be used with the CM-26dG

Notes When using this target mask, the measurement accuracy will be decreased due to the influence of the glass element. This must be taken into account when comparing samples using the standard accessory target mask.

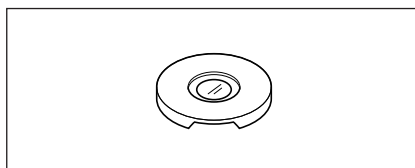

Replacement lithium-ion battery CM-A235 (RRC1120)*

This battery is a replacement for the standard lithium-ion battery.

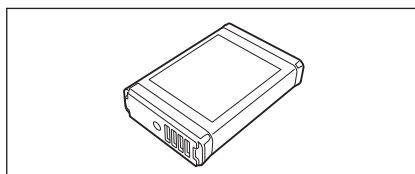

WLAN / Bluetooth module CM-A300*

Used for establishing wireless communication and transferring data between the instrument and a computer or a printer.

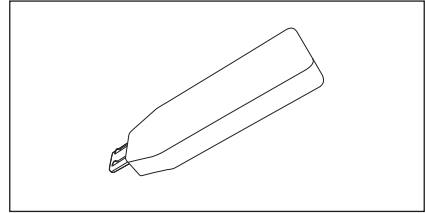

Color Data Software SpectraMagic NX2

A PC software used to control the instrument and manage data from a computer.

You can download it from the USB memory or <https://www.konicaminolta.com/instruments/download/software/color/smnx2/index.html>.



Charger CM-A237 (RRC-SCC 1120)*

Used as the dedicated charger to charge the lithium-ion battery.

An AC adapter for charging is included.

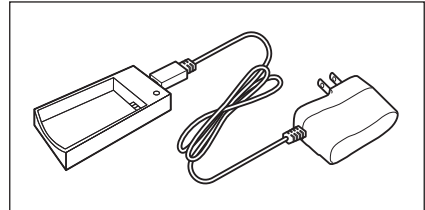

Color Plates (White, black, and 12 other colors)

Used for simple diagnosis of instrument measurement performance (instrumental errors and repeatability).

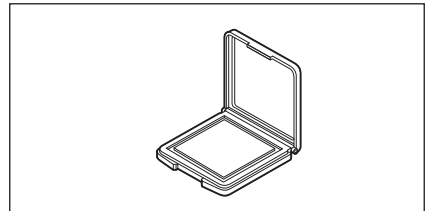

System Diagram

CM-26dG



**Spectrophotometer Configuration Tool
CM-CT1**
* Available for download on the Web at no extra charge
* SpectraMagic NX2 is required to use some functions.

Computer
(commercially available)

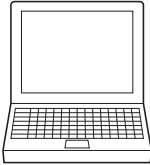

Standard Accessories

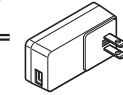

AC Adapter
AC-A305J/L/M*



USB Cable (2 m)
IF-A28



Wrist Strap
CR-A73

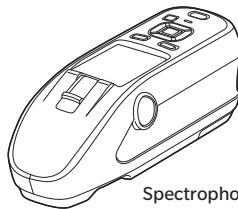

Spectrophotometer
CM-26dG

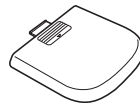

Flat Type Battery Cover
CM-A218

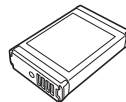

Lithium-ion Battery
CM-A235*

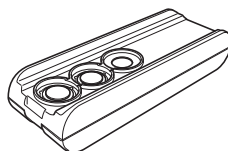

Calibration Stage
(for CM-26dG)
CM-A274



Cleaning Cloth

Optional Accessories



Color Data Software
SpectraMagic NX2
* Available on USB memory or for download from the Web

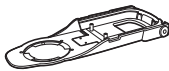

Stapler Type
Target Mask
CM-A268



Target Sheet
(for gloss)
CM-A269



Color Plates
(14 colors)



WLAN / Bluetooth Module
CM-A300*



Bluetooth Printer
(commercially available)
(Other rolled paper)

Optional Accessories



Battery Charger **CM-A237***

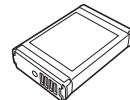

Lithium-ion Battery
(spare)
CM-A235*



Hard Case **
CM-A267

———— Standard Accessories

----- Optional Accessories

==== Connection possible

* Depending on the location, some accessories may not be available.

** May be included as a standard accessory in some regions.

Memo The shape of some products may be different from those shown.

CM-26d



Spectrophotometer Configuration Tool CM-CT1

- * Available for download on the Web at no extra charge
- * SpectraMagic NX2 is required to use some functions.

Computer
(commercially available)

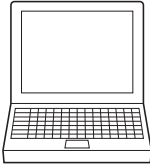

Standard Accessories

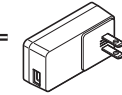

AC Adapter
AC-A305J/L/M*



USB Cable (2 m)
IF-A28



Wrist Strap
CR-A73



Spectrophotometer
CM-26d

Optional Accessories



Color Data Software
SpectraMagic NX2
* Available on USB memory or for download from the Web

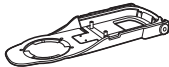

Stapler Type
Target Mask
CM-A268



Target Sheet (MAV) **CM-A270**
Target Sheet (SAV) **CM-A271**



Target Mask (MAV; w/ glass)
CM-A277



Color Plates
(14 colors)



WLAN / Bluetooth Module
CM-A300*



Bluetooth Printer
(commercially available)
(Other rolled paper)

Optional Accessories



Battery Charger **CM-A237***

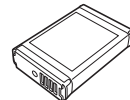

Lithium-ion Battery (spare)
CM-A235*



Hard Case **
CM-A267



Target Mask (MAV)
CM-A272



Target Mask (SAV)
CM-A273

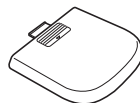

Flat Type Battery Cover
CM-A218

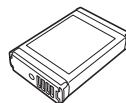

Lithium-ion Battery
CM-A235*

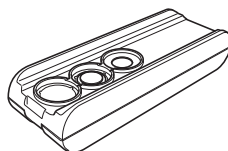

Calibration Stage (for CM-26d)
CM-A275

———— Standard Accessories

- - - - - Optional Accessories

==== Connection possible

* Depending on the location, some accessories may not be available.

** May be included as a standard accessory in some regions.

Memo The shape of some products may be different from those shown.

CM-25d



Spectrophotometer Configuration Tool

CM-CT1

- * Available for download on the Web at no extra charge
- * SpectraMagic NX2 is required to use some functions.

Computer
(commercially available)

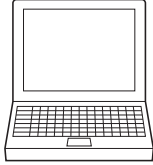

Standard Accessories

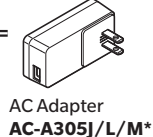

AC Adapter
AC-A305J/L/M*



USB Cable (2 m)
IF-A28



Wrist Strap
CR-A73

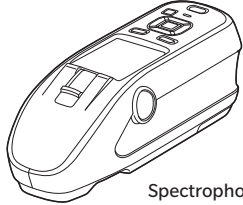

Spectrophotometer
CM-25d

Optional Accessories

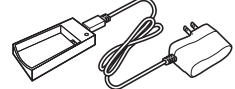

Battery Charger **CM-A237***

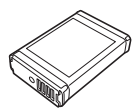

Lithium-ion Battery
(spare)
CM-A235*



Hard Case **
CM-A267

Optional Accessories



Color Data Software
SpectraMagic NX2
* Available on USB memory or for download from the Web

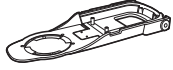

Stapler Type
Target Mask
CM-A268



Target Sheet (MAV)
CM-A270



Target Mask
(MAV; w/ glass)
CM-A277



Color Plates
(14 colors)



WLAN / Bluetooth Module
CM-A300*



Target Mask
(MAV)
CM-A272

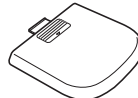

Flat Type Battery Cover
CM-A218

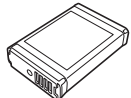

Lithium-ion Battery
CM-A235*

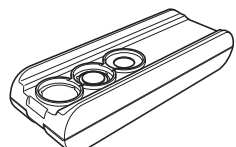

Calibration Stage
(for CM-25d)
CM-A276



Bluetooth Printer
(commercially available)
(Other rolled paper)

- Standard Accessories
- - - - - Optional Accessories
- ==== Connection possible

* Depending on the location, some accessories may not be available.

** May be included as a standard accessory in some regions.

Memo The shape of some products may be different from those shown.

Names and Functions of Parts

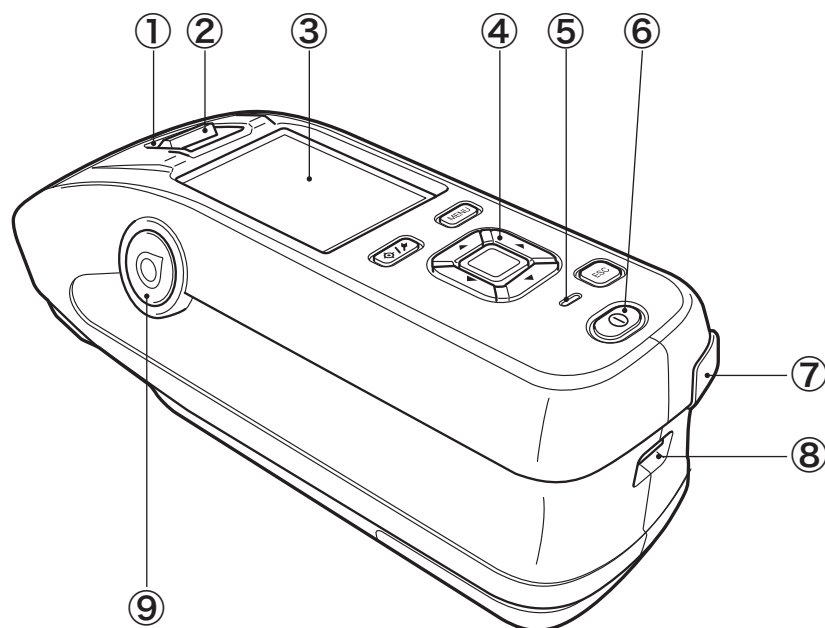

- | | |
|---|--|
| <p>① Viewfinder
(Specimen confirmation window)</p> | <p>Using the viewfinder, users can confirm the measurement location of the specimen. Open the shutter to check the measurement location of the specimen.</p> |
| <p>② Viewfinder lever</p> | <p>This lever opens the specimen confirmation window.</p> |
| <p>③ LCD screen</p> | <p>Displays setting items, measurement results and messages.</p> |
| <p>④ Control panel</p> | <p>Used to switch screens or select/determine/save setting items. For details, refer to P.24 "Operation Keys".</p> |
| <p>⑤ Charging lamp</p> | <p>Lights up orange when charging via USB power. When charging is complete, the lamp will turn green.</p> |
| <p>⑥ Power switch</p> | <p>Used to turn ON/OFF power. The instrument switches between ON/OFF every time the power switch is pressed.</p> |
| <p>⑦ USB connection terminal
(Mini-B type)</p> | <p>Used to connect the instrument to a computer with the supplied USB cable (IF-A28).</p> |
| <p>⑧ Wrist strap attachment hole</p> | <p>Used to attach the wrist strap.</p> |
| <p>⑨ Measurement button</p> | <p>Used to perform measurement. A measurement button can be found on both the right and left sides of the instrument. Either button can be used for measurement.</p> |

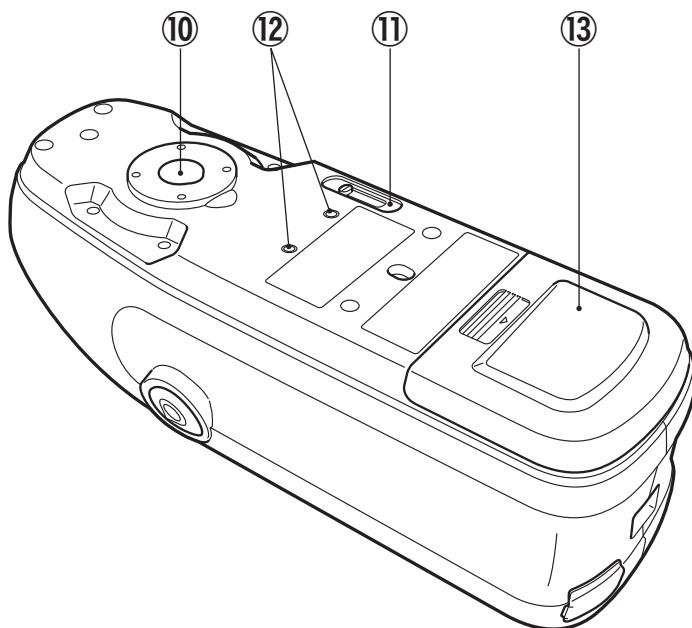

⑩ **Sample surface aperture**

This is the aperture for measuring samples.

⑪ **Measurement area switch**

Switches the measurement area.

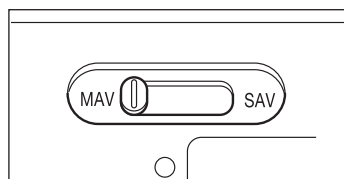

Memo The CM-25d does not include this switch.

⑫ **Mounting screw holes for accessories**

Used to mount accessories.

⑬ **Battery cover**

Slide this cover open to replace the battery or to attach the WLAN / Bluetooth module.

Memo When the measurement surface and the bottom of the instrument are the same height, the standard battery cover should be used. When the measurement surface is lower than the bottom of the instrument, the supplied flat-type cover should be used.

□ Calibration Stage

CM-26dG

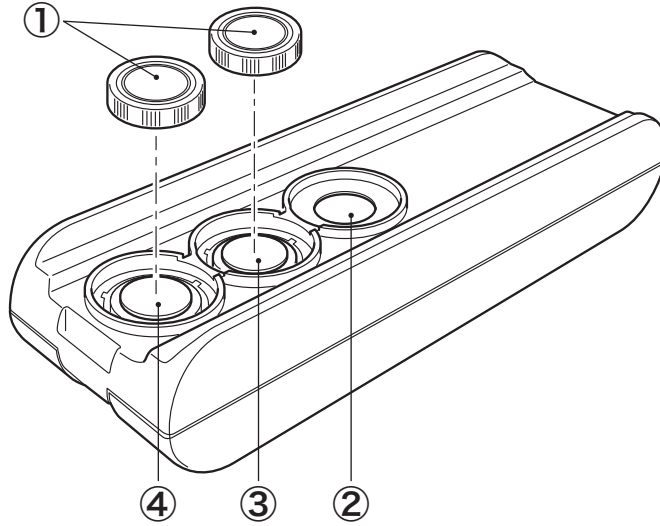

CM-26d

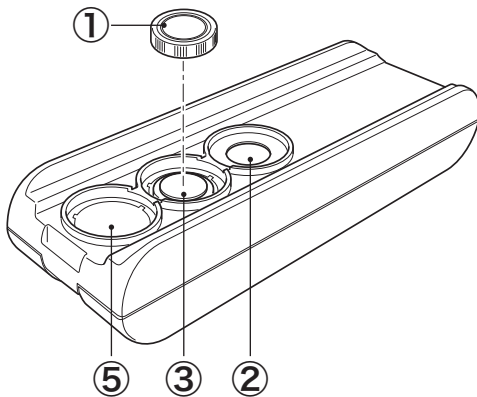

CM-25d

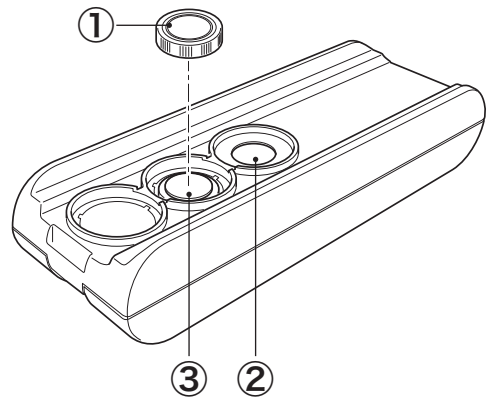

① Cap

This black cap is used to protect the white calibration plate and the gloss calibration plate.

Notes Attach the cap to the white calibration plate and the gloss calibration plate when they are not being used.

Memo Only one cap for the white calibration plate is included with the CM-26d/CM-25d.

② Zero calibration hole

Used to perform zero calibration.
Make sure no dust gets into the zero calibration hole.

③ White calibration plate

Used to perform white calibration. When the plate is not being used, use the lid to prevent the plate from becoming dusty or scratched and to protect it from external light.

④ Gloss calibration plate (CM-26dG only)

Used to perform gloss calibration. When the plate is not being used, use the lid to prevent the plate from becoming dusty or scratched and to protect it from external light.

⑤ Target mask holder (CM-26d only)

Used to store unused target masks.

■ Cleaning the Components

□ Zero Calibration Hole (Calibration Stage)

Use a blower to blow off any dust on the inclined surface inside the zero calibration hole. In addition, direct cleaning with the blower can be performed by removing the cover. If the dirt does not come off easily, wipe using a soft cloth soaked in ethanol. In such cases, be careful not to leave behind fingerprints or the like.

□ White Calibration and Gloss Calibration* (* CM-26dG only)

- If the white calibration plate or the gloss calibration plate becomes dirty, gently wipe the dirt off using the cleaning cloth* included as a standard accessory.
- If the dirt on the white calibration plate or the gloss calibration plate does not come off easily, wipe using a cloth soaked in ethanol.
- When a part other than the calibration plate becomes dirty, lightly wipe the dirt off with a cloth dampened with water or soapy water.

- Notes**
- **Be careful not to scratch the calibration plate.**
 - **Never use solvents such as thinner or naphtha.**
 - **Scratches or dirt on the white calibration plate or the gloss calibration plate may affect measurement values.**

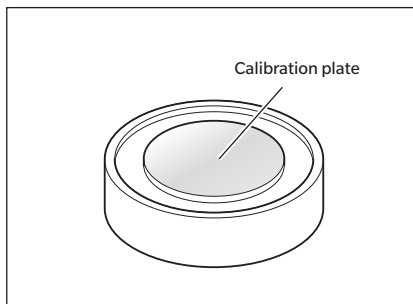

□ Target Mask

CM-26dG

- Use a blower to blow off dirt or dust on the target mask.
- If the dirt on the outside surface of the target mask does not come off easily, wipe using a soft cloth soaked in ethanol.

- Notes** Do not touch the painted surface of the integrating sphere.

CM-26d, -25d, MAV target mask (with glass)

- Use a blower to blow off dirt or dust on the target mask.
- If the dirt on the outside or inside surface of the target mask does not come off easily, remove the target mask from the instrument, and wipe the target mask using a soft cloth soaked in ethanol.

- Notes**
- **Take sufficient care when handling the target mask with glass.**
 - **The glass of the target mask may become cracked, resulting in injury.**
 - **Remove any iron on magnets of the target mask mounting surface.**

□ Inside the Integrating Sphere

Use a blower to blow off dust or dirt inside the integrating sphere.

- Notes** Do not touch the white-coated inner surface of the integrating sphere, wipe it with a cloth or put an object inside it. If the target mask is dirty, and the dirt cannot be removed by a blower or the like, contact a KONICA MINOLTA-authorized service facility.

Points to Remember

■ Initial Settings

When first turning the instrument ON after purchasing, the language setting screen will be displayed. Please select the language. The language selection menu can be displayed by turning ON the instrument while holding down **[MENU]**.

The display language can be selected from 11 languages including English.

For details, refer to P.108 "Measurement Instrument Option Settings".

■ Control Panel

The front of the instrument contains the LCD screen, upon which the instrument displays measurement results and messages, and the control keys, which are used to set measurement options or to change displays.

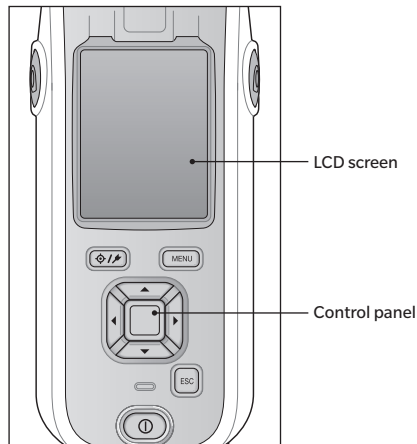

□ Display (LCD Screen)

The LCD screen displays measurement settings, measurement results, and messages. It also indicates the status of the instrument with icons.

The basic screen layout is shown below.

The screenshot shows the following data on the LCD screen:

- Status bar:** I+E, Wi-Fi, M, and a battery icon.
- Time:** 17:53
- Target/Sample:** Sample 0001
- Data number and name:** 0006 (with a checkmark icon)
- Observer/Illuminant 1:** 2°/D65
- Observer/Illuminant 2:** 10°/F2
- Measurement Area Table:**

	2°/D65	10°/F2
ΔL^*	0.21	0.17
Δa^*	-0.62	-0.47
Δb^*	-0.08	-0.15
ΔE^*_{ab}	0.66	0.52
ΔGU	-0.95	-0.85
HI	0.17	0.17
- Measurement date/time:** 2018/09/10 07:57:15
- Target reference (sample) / Affiliated group (target):** 0001
- Bottom right:** 3/14









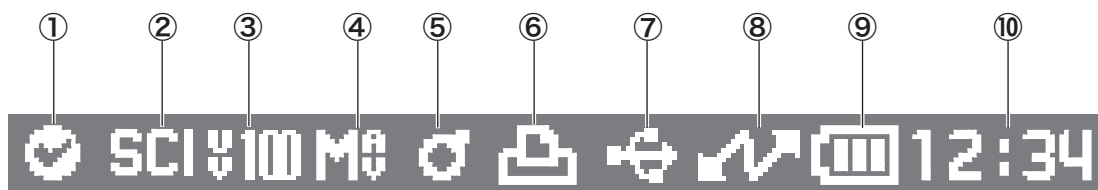



















Callouts from the image:

- Status bar:** I+E, Wi-Fi, M, and a battery icon.
- Target/Sample:** Sample 0001
- Data number and name:** 0006
- Observer/Illuminant 1:** 2°/D65
- Observer/Illuminant 2:** 10°/F2
- Data/graph display area:** Points to the measurement area table.
- Measurement date/time:** 2018/09/10 07:57:15
- Target reference (sample) / Affiliated group (target):** 0001
- Bottom right:** 3/14
- Target to be used for association with the next measurement or filter (target):** Points to the checkmark icon.
- Pass/fail result:** Points to the checkmark icon.
- UV setting:** Displays the UV setting status.
- Color is applied when the tolerance is exceeded or when a warning occurs. (sample):** Points to the orange background of the ΔGU row.
- Measurement area:** Points to the measurement area table.
- “!” is displayed when the calibration interval has arrived, when measurement is performed with an insufficient amount of light, or when the sample is outside the guaranteed range.** Points to the “!” icon in the bottom right.
- Display type of currently displayed screen:** Points to the “3/14” indicator.

□ Status bar

This section describes the icons displayed at the top of the screen.



	Display	Description (Status)	Meaning
①	 /  / None	Instrument diagnosis result	Pass / Check required / No diagnosis (* Support for this function is planned with optional PC software. It is not currently available.)
②	 /  / 	Specular component status	SCI / SCE / SCI+SCE
③	 /  /  / 	UV setting	UV 100% / UV 0% / UV 100% + 0% / UVC (UV control)
④	 / 	Measurement area	MAV / SAV
⑤	 /  / 	Calibration status	Measurement possible / Measurement possible (calibration recommended) / Calibration required
⑥	 / None	Auto print	Auto print ON / OFF
⑦	 /  /  / None	Wireless communication	WLAN communication / Bluetooth communication / OFF
⑧	 /  / None	Communication status	Communication ON / Communication key ON / Communication OFF
⑨	 /  /  /  /  /  /  / 	Power status	Battery capacity (Full/OK/Low) / Charging / External power/battery status (Full/OK/Low/None)
⑩		Current time	Hour: Minute

□ Operation Keys

Use these keys to set items or change screens according to the guide on the LCD screen.

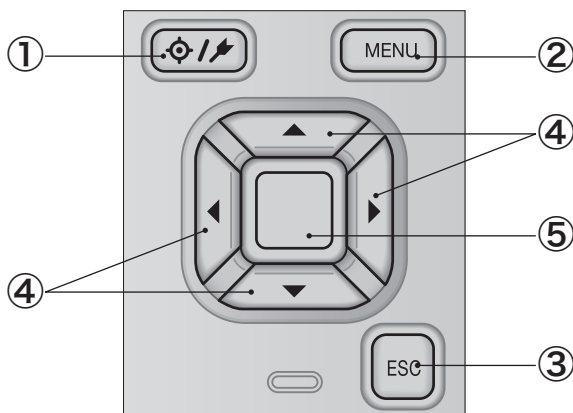

- ① [**☉ / ↗**] (**Target/Sample**) key Switches between **<Target> screen** and **<Sample> screen**.
- ② [**MENU**] key Displays the **<Settings> screen**.
- ③ [**ESC**] key Returns to the previous screen without configuring the settings when pressed on the **<Settings> screen**, and returns to list screen when pressed on the sample details screen.
- ④ [**◀, ▶, ▲, ▼**] keys Switches screen tabs from the **<Results Display> screen**, moves the cursor on the **<Settings> screen**, or changes the selected value.
- ⑤ [**Confirmation**] key Sets the item or setting indicated by the cursor on the various setting screens. This key also switches to detail screens for data selected in the list displayed on the **<Results Display> screen**.

■ Menus

Target menu

Print data P.63

Edit name P.64

Data management

Delete data P.65

OK/Cancel

Set group P.66

OK/Cancel

Edit group

Change list position P.67

Target value No. selection

Edit Target filter P.68

OFF / Only saved data / Only group

Protect data P.69

OFF/ON

Delete all data P.70

OK/Cancel

Pass/Fail

Edit tolerance P.72

OK/Cancel

Tolerance list P.73

Index selection

Warning level P.74

0 to 100%

Parametric coef. P.75

l (CMC), c (CMC),
l (ΔE^*94), c (ΔE^*94),
h (ΔE^*94), l ($\Delta E00$),
c ($\Delta E00$), h ($\Delta E00$)

Input colorimetric data

Color space P.76

XYZ/L*a*b*/Hunter Lab

Input data P.77

Sample menu

Print data P.51

Edit name P.52

Data management

Delete data P.53

OK/Cancel

Set Sample as Target P.54

Target No. selection

Change Target Reference P.55

Target No. selection

Change list position P.56

Sample No. selection

Delete all data P.57

OK/Cancel

Auto target

Auto target P.58

OFF/ON

Threshold P.59

0.01 to 9.99

Measurement cond.

Measurement mode P.88

Color & Gloss / Color only / Gloss only / Opacity

Measurement setup

Specular component P.92

SCI / SCE / SCI+SCE

UV P.93

UV100% / UV0% /
UV100%+0% / UVC

Auto average P.94

1 to 10 times

Manual average P.95

1 to 30 times

Manual average option (SMC average option) P.95

Manual save / Auto save

SMC P.96

OFF/ON

SMC Threshold P.97

0.01 to 9.99

SMC Times P.98

3 to 10 times

Observer/Illuminant

Observer/Illuminant 1 P.100

2°A/C/D50/D65/ID50/ID65/F2/F6/
F7/F8/F10/F11/F12/LED-B1/LED-B2/
LED-B3/LED-B4/LED-B5/LED-BH1/
LED-RGB1/LED-V1/LED-V2/User
10°A/C/D50/D65/ID50/ID65/F2/F6/
F7/F8/F10/F11/F12/LED-B1/LED-B2/
LED-B3/LED-B4/LED-B5/LED-BH1/
LED-RGB1/LED-V1/LED-V2/User

Observer/Illuminant 2 P.102

2°A/C/D50/D65/ID50/ID65/F2/F6/
F7/F8/F10/F11/F12/LED-B1/LED-B2/
LED-B3/LED-B4/LED-B5/LED-BH1/
LED-RGB1/LED-V1/LED-V2/User
10°A/C/D50/D65/ID50/ID65/F2/F6/
F7/F8/F10/F11/F12/LED-B1/LED-B2/
LED-B3/LED-B4/LED-B5/LED-BH1/
LED-RGB1/LED-V1/LED-V2/User/None

Display cond.

Display type P.104

Absolute value, Difference, Abs. &
Diff., Pass/Fail, Custom, Abs.
Graph, Diff. Graph, Spectral Graph

Color space P.105

L*a*b*, L*C*h, Hunter Lab,
Yxy, XYZ, Munsell (C)

Color difference equation	P.106
ΔE^*ab , CMC, ΔE^*94 , $\Delta E00$, ΔE (Hunter), $\Delta E99o$, FMC2	

Custom 01 to 14	P.107
L*, a*, b*, ΔL^* , Δa^* , Δb^* , C*, h, ΔC^* , ΔH^* , L, a, b, ΔL , Δa , Δb , X, Y, Z, DXYZ, DX, DY, DZ, ΔX , ΔY , ΔZ , x, y, Δx , Δy , H, V, C, ΔE^*ab , CMC, ΔE^*94 , $\Delta E00$, ΔE (Hunter), MI, <u>GU</u> , <u>ΔGU</u> , Wle, ΔWle , Wlc, ΔWlc , Tint, $\Delta Tint$, Yle, ΔYle , Yld, ΔYld , B, ΔB , $\Delta E99o$, Greyscale (ISO A105), WI (Ganz), ΔWI (Ganz), Tint (Ganz), $\Delta Tint$ (Ganz), Staining ISO 105-A04, FMC2, $\Delta L(FMC2)$, $\Delta Cr-g(FMC2)$, $\Delta Cy-b(FMC2)$, K/S St(ΔE^*), K/S St(MAX Abs), K/S St(Apparent), UE1, UC1, UE2, UC2, UE3, UC3, --- (None)	

* Underlined items become 8°GU for CM-26d/CM-25d.

Instrument Mode

Normal/Simple

Default data setup

Default tolerance	P.81
OK/Cancel	

Warning level	P.82
0 to 100%	

Parametric coef.	P.83
I (CMC), c (CMC), I (ΔE^*94), c (ΔE^*94), h (ΔE^*94), I ($\Delta E00$), c ($\Delta E00$), h ($\Delta E00$)	

Set group	P.84
Group number selection → Group name setting	

Calibration setup

Calibration interval	P.138
01 to 24 hours	

Annual calibration	P.139
OFF/ON	

User calibration	P.140
OFF/ON	

Zero calibration skip	P.141
Disable/Enable	

Communication setup

Auto print	P.135
OFF/ON	

Wireless Settings	P.124
OFF / Bluetooth / AdHoc / Infrastructure1 / Infrastructure2 / Infrastructure3 / Infrastructure4	

WLAN Info.	P.127
WLAN method, IP address, SSID, Version	

Meter PIN code	P.125
4 to 8 digits (Initial value is "0000")	

Printer address	P.132
000000000000	

Printer PIN code	P.133
4 to 8 digits (Initial value is "0000")	

Scanner address	P.132
000000000000	

Scanner PIN code	P.133
4 to 8 digits (Initial value is "0000")	

Instrument setup

User type	P.109
Administrator / Worker	

Language	P.110
English / 日本語 / Deutsch / Français / Español / Italiano / 中文 / Português / Polski / Русский язык / Türkçe	

Date format	P.111
[yyyy/mm/dd]/[mm/dd/yyyy]/[dd/mm/yyyy]	

Date & time	P.112
0000/00/00 00:00	

Brightness	P.113
5/4/3/2/1	

Direction	P.114
-----------	-------

Beep	P.115
OFF/ON	

Auto power off	P.116
00 to 60 minutes	

Password setting	P.117
8 digits (Initial value is "00000000")	

Wake On Mode	P.118
ON/OFF	

Diagnosis info.

Diagnosis info. display	P.142
-------------------------	-------

Instrument info.

Product name, Version, Serial No.	P.143
-----------------------------------	-------

Calibration

Calibration (Including Zero Cal.)	P.35
Zero calibration → White calibration → Gloss calibration	

Calibration (Excluding Zero Cal.)	P.37
White calibration → Gloss calibration	

JOB

JOB 1 to 5

■ Data Saving

Data used with this instrument are saved automatically within the instrument.

Data on the instrument can also be imported to a computer using the optional accessory Color Data Software "SpectraMagic NX2".

Chapter 2

Measurement

Flow of Measurement	29
Preparation	30
Calibration.....	35
Zero calibration.....	35
White Calibration and Gloss Calibration	37
User calibration	39
Setting a Specimen	40
Viewfinder.....	40
Measurement	41
Displaying the Measurement Results	42
Measurement (Simple Mode).....	48
Handling the Sample	50
Print Data (Sample).....	51
Edit name	52
Data Management (Sample)	53
Auto Target (Sample)	58
Pass/Fail Judgment for Color Difference.....	60
Pass/Fail Judgment Based on Tolerances.....	60
Color Difference Target Operation.....	62
Print Data (Target)	63
Edit name	64
Data Management (Target)	65
Pass/Fail.....	71
Input Colorimetric Data	76
Default Data Settings	79

Flow of Measurement

■ Optional settings

■ Basic procedure

■ Simple measurement

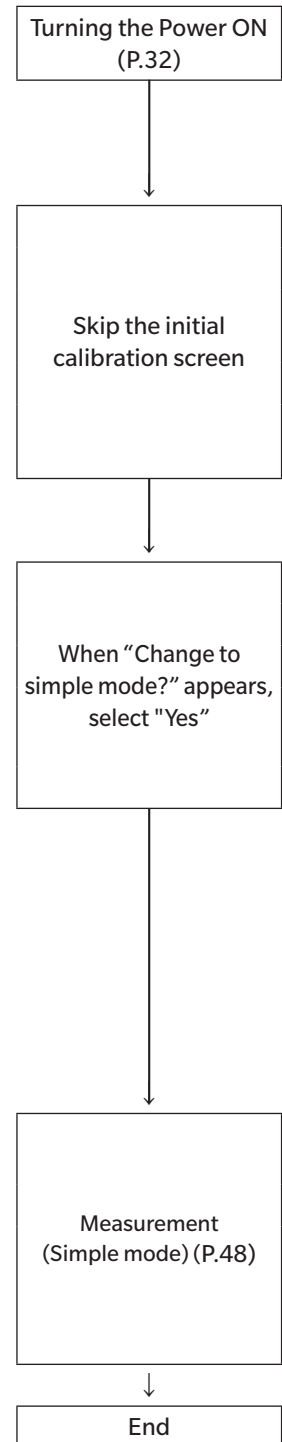
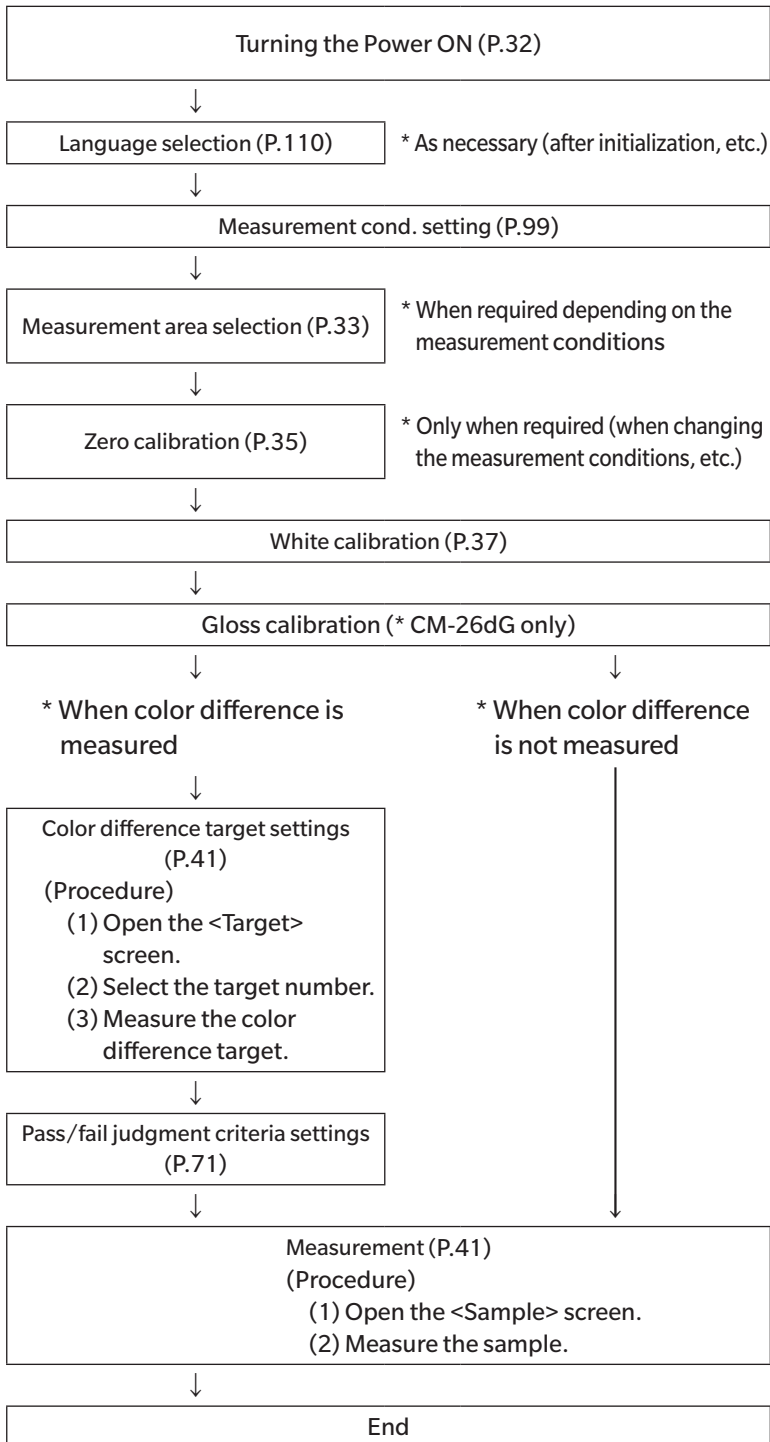

* Configure measurement/observation conditions and perform calibration as necessary.

Preparation

Attach the Wrist Strap

Attaching the Wrist Strap

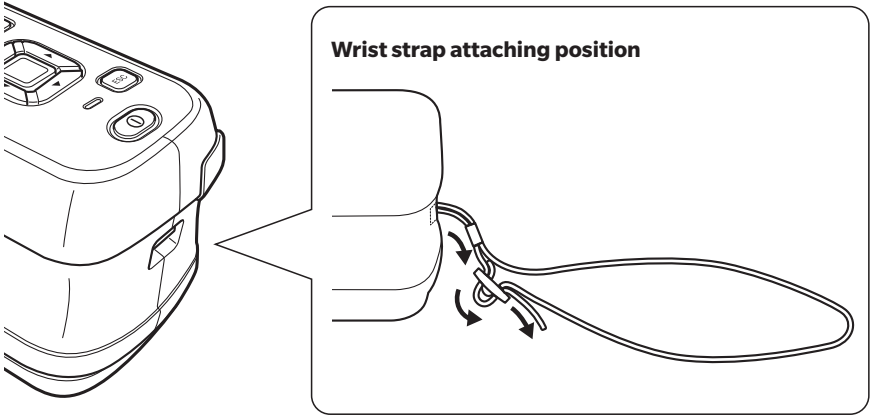

□ Inserting the Battery

This instrument can be powered from a lithium-ion battery, but use of the AC adapter or USB bus power is recommended for extended periods of use. A lithium-ion battery installed in the instrument will be charged whenever the AC adapter or USB bus power is used, regardless of whether the instrument is turned ON or OFF.

Notes When using USB bus power, use a computer that meets IEC 62368-1 (Audio/video, information and communication technology equipment - Part 1: Safety requirements) standards.

⚠ CAUTION

- Do not touch or short-circuit the terminals in the battery compartment. Doing so may damage the instrument.

Operating Procedure

1 Turn the power OFF by operating the power switch.

2 Slide open the battery cover on the bottom of the instrument.

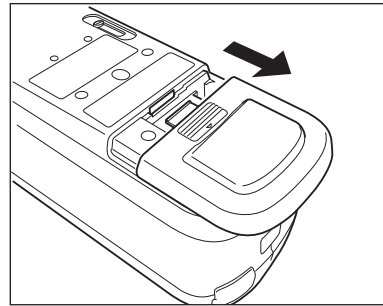

3 Rotate the battery retainer and insert the lithium-ion battery. (Follow the indications in the battery compartment to avoid confusing the battery polarity.)

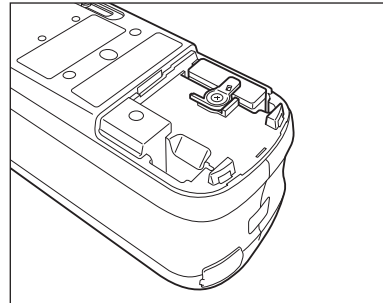
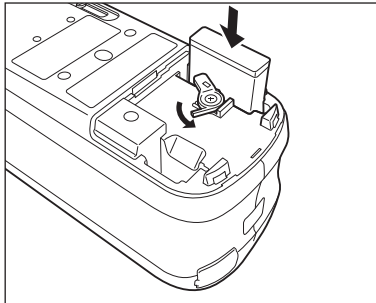

4 Slide the battery cover to close it.

□ Connecting the AC Adapter

- Notes**
- The lithium-ion battery must always be installed, even when using external power.
 - To supply AC power to the instrument, always use the AC adapter (AC-A305J/L/M) supplied with the instrument.
 - Firmly push the AC adapter power plug or USB cable completely into the outlet.

Memo Powering the instrument from the USB cable will charge the installed lithium-ion battery. While the battery is charging, the charging lamp on the instrument's panel will light up orange. When charging is complete, the lamp will turn green.

Operating Procedure

- 1 **Open the connector's protective cover, and connect the USB cable to the USB port on the instrument.**
- 2 **Connect the USB cable to the AC adapter, and then connect the AC adapter plug to a 100 to 240 VAC (50/60 Hz) power outlet.**

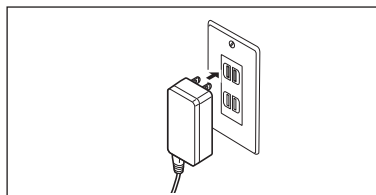
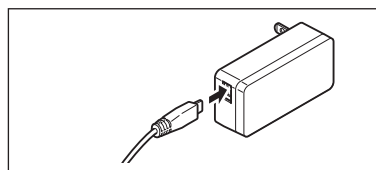
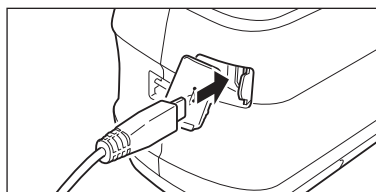

□ Turning the Power ON/OFF

Operating Procedure

Turning the Power ON

- 1 **With the power OFF, press and hold the power switch for about 1 second.**
The power will turn ON.

- Notes**
- When first turning the instrument ON after purchasing, the language setting screen will be displayed, followed by the date and time setting screen. Configure the settings according to P.110 and P.111.

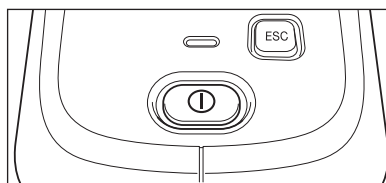

Operating Procedure

Turning the Power OFF

- 1 **Press and hold the power switch for about 1 second.**
The power will turn OFF after the settings have been saved.

- Memo** When powered by the battery, the instrument will turn OFF automatically after 5 minutes of inactivity. Due to data protection within the instrument, powering down may take several seconds to several tens of seconds.

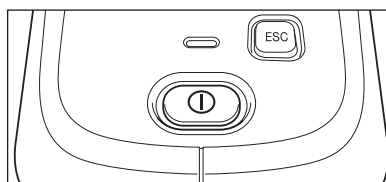

□ Measurement Area Selection (CM-26dG/CM-26d)

Select the measurement area.

The selected measurement area can be checked on the status bar displayed on the screen. (Refer to P.23.)

Operating Procedure

Operate the measurement area switch on the instrument.

- 1 Use the measurement area switch on the bottom of the instrument to set the measurement area to MAV or SAV.

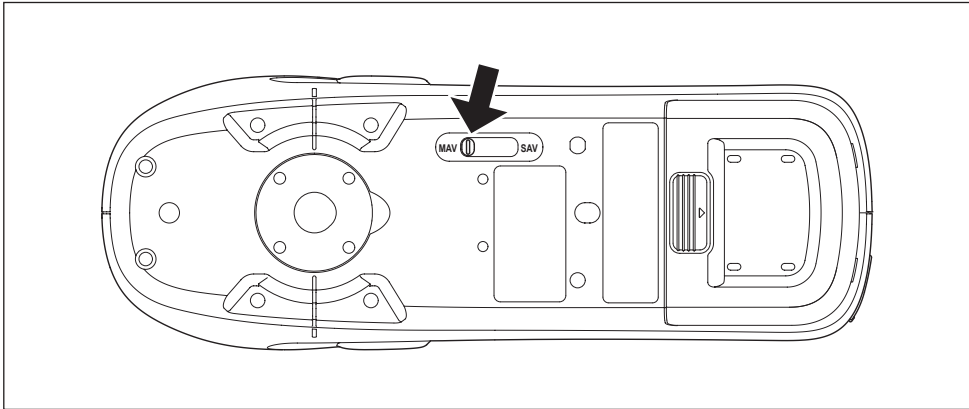

Setting

- MAV : Measurement area of 8 mm (10×7 mm with gloss measurement)
- SAV : Measurement area of 3 mm

□ Target Mask Replacement (CM-26d/CM-25d)

Replace the target mask according to the sample to measure.

Notes

- Fit the target mask securely so that the bottom is parallel to the instrument.
- Make sure the measurement area set for the instrument matches the diameter of the target mask being used.

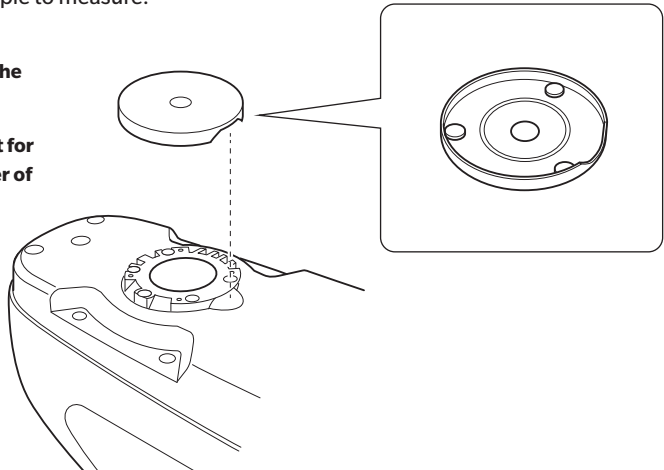

Using the optional stapler type target mask (CM-A268) makes it possible to accurately aim where measurement will be performed.

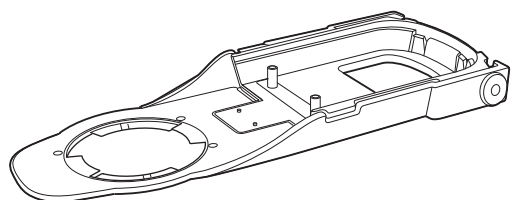

□ Staple-Type Target Mask

■ Attaching the Target Mask

Attach the stapler type target mask so that the two protrusions of the target mask are inserted into the 2 holes on the bottom of the instrument, and push in until the tab on the rear end of the target mask catches on the instrument and clicks.

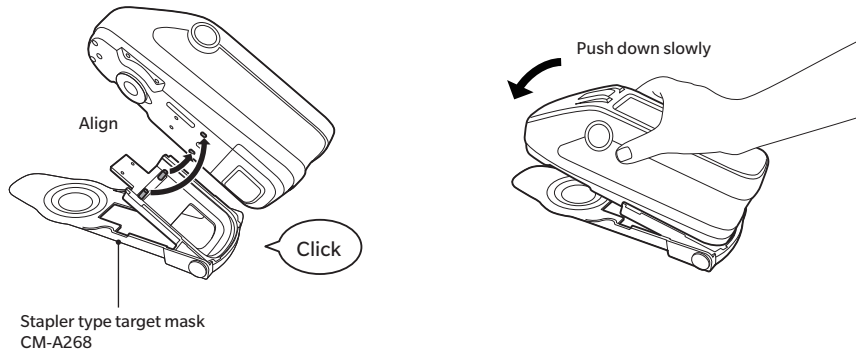

Memo

- Secure the target mask by tightening screws into the mounting screw holes for accessories on the instrument (refer to P.18).
- Use any of the following screws to secure the target mask.
 - ① CM-A280 (Stapler type target mask coupling screws)
 - ② Screws with the following dimensions: M3 (thread size) × 4 mm (length) × Ø5.5 to 6 (head diameter) × 2 mm or less (head height)

Notes

Using screws other than the above may result in damage to the instrument or the target mask, scratches on the measurement sample, or incorrect measurement values.

■ Attaching/Removing the Target Sheet

1. Attach a target sheet to the stapler type target mask as necessary for the application.

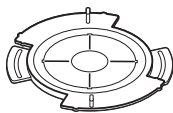

For gloss
CM-A269
(CM-26dG only)

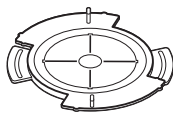

MAV (Ø8 mm)
CM-A270

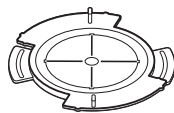

SAV (Ø3 mm)
CM-A271

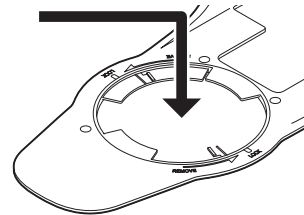

2. Align the notch and rotate in the direction indicated by the arrow.

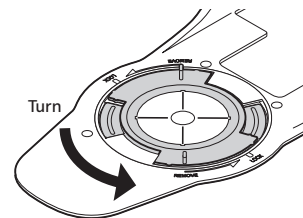

3. The sheet will be locked when a "click" is heard.

- Perform the procedure in reverse to remove.

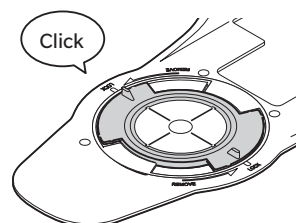

Calibration

Select the measurement area using the switch beforehand.

Three types of calibration can be performed with this instrument.

- Zero calibration : Only the amount of stray light is measured in advance in order to eliminate the effects of the stray light.
- White calibration : The reflectance is measured in advance using a known calibration plate in order to provide a reflectance scale.
- Gloss calibration : The gloss is measured in advance using a known calibration plate in order to provide a gloss scale.

This calibration is performed after white calibration with this instrument. (CM-26dG only)

Calibration Stage

Use a calibration stage with the same number as that printed on the nameplate of the instrument.

Newly purchased calibration stages will have a different number than that shown on the nameplate of the instrument. Make sure the calibration plate ID displayed on the <Calibration> screen matches the calibration stage number.

Calibration data will need to be written (updated) any time you purchase a new calibration stage. Use the Spectrophotometer Configuration Tool CM-CT1 to write calibration data. For details, refer to "New White Calibration Plate / Gloss Calibration Plate" in the CM-CT1 manual.

Zero calibration

Since this instrument stores the data of the previous zero calibration, repeating zero calibration every time the instrument is turned ON is not necessary. If, however, the measurement conditions change greatly, the instrument is not used for a long period of time, or when using a MAV target mask (with glass), zero calibration must be performed before white calibration.

Memo

- The effects of stray light (i.e., light generated due to the flare characteristics of the optical system) will be compensated for automatically by the zero calibration data.
- The amount of stray light may change because of dust or dirt that has collected in the optical system, humidity, repeated operation, or vibration and shock exerted on the instrument. In this case, performing zero calibration periodically is recommended.

Notes

- **If the instrument is not used for long periods of time, the zero calibration data stored in the instrument may be lost. If the data is lost, zero calibration must be performed again.**
- **Before using the MAV target mask (with glass), it is necessary to set "Zero cal. skippable" (P.141) to "OFF" in advance.**

Operating Procedure

Start the procedure from the measurement screen.

- 1 Press [MENU], and then use [◀] or [▶] to display the <Calibration> screen.

Notes

- The following screen prompting calibration is displayed when the instrument starts up. If zero calibration has not been performed, the cursor will appear on "Calibration (Including Zero Cal.)". Otherwise, the cursor will appear on "Calibration (Excluding Zero Cal.)".

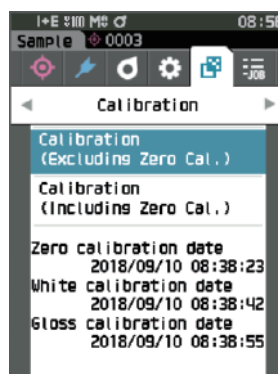
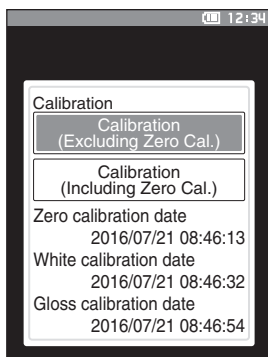

- 2 Use [▲] or [▼] to move the cursor to “Calibration (Including Zero Cal.)”, and then press the [Confirmation] key.

- 3 Set the instrument in the calibration stage to measure the calibration stage’s zero calibration hole.

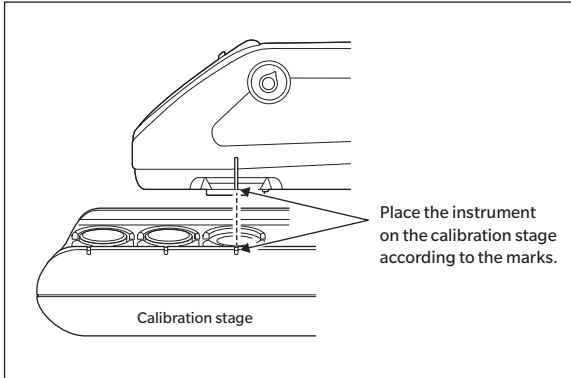

- 4 Press the measurement button.

Zero calibration will be performed.

- Notes**
- Do not move the instrument until zero calibration is complete.

When zero calibration is completed, a screen prompting white calibration is displayed. Continue to step 3 on the following page to perform white calibration.

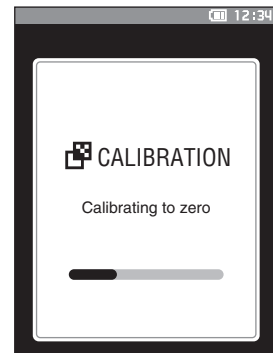

White Calibration and Gloss Calibration

A message prompting white calibration is displayed on the instrument after the power is turned ON.

Memo

- If the calibration interval is turned ON and a time is configured, a message prompting white calibration will be displayed the next time the power is turned ON or when measurement is performed after the set time has passed since the previous white calibration. (Refer to P.138 “Calibration Interval Messages”)
- The reading may fluctuate slightly due to changes in the ambient temperature or due to heat generation caused by repeated operation of the instrument. In such cases, perform white calibration regularly.
- Calibration details may vary according to the measurement mode (refer to P.88). When the measurement mode is set to “Color & Gloss”, white calibration and gloss calibration will be performed. When the mode is set to “Color only”, only white calibration will be performed. When the mode is set to “Gloss only”, only gloss calibration will be performed.

Notes

- **White calibration must be performed at the same temperature at which measurement will be performed.**
- **Perform white calibration after the instrument has had time to adapt to the ambient temperature.**

Operating Procedure

Start the procedure from the measurement screen.

Although white calibration can be performed from the prompt when the power is turned ON and from the screen following zero calibration, the following explains the procedure to perform white calibration from the measurement screen.

1 Press [MENU], and then use [◀] or [▶] to display the <Calibration> screen.

Notes

- **The following screen prompting calibration is displayed when the instrument starts up. If zero calibration has not been performed, the cursor will appear on “Calibration (Including Zero Cal.)”. Otherwise, the cursor will appear on “Calibration (Excluding Zero Cal.)”.**

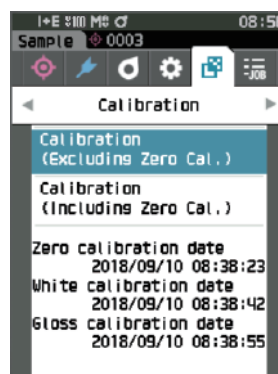
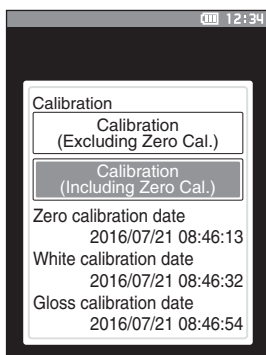

2 Use [▲] or [▼] to move the cursor to “Calibration (Excluding Zero Cal.)”, and then press the [Confirmation] key.

3 Set the instrument in the calibration stage in order to measure the calibration stage's white calibration plate.

- Notes**
- Verify that the White ID shown on the screen and the calibration stage number match.

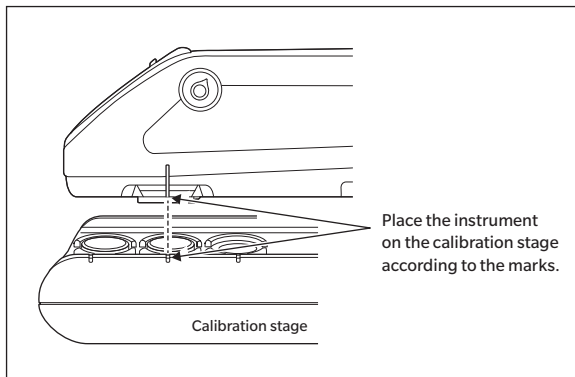

4 Press the measurement button.

White calibration will be performed.

- Notes**
- Do not move the instrument until white calibration is complete.

After white calibration is complete, a screen prompting gloss calibration will be displayed.



5 Set the instrument in the calibration stage in order to measure the calibration stage's gloss calibration plate.

- Notes**
- Gloss calibration is only available with the 26dG.
 - Verify that the Gloss ID shown on the screen and the calibration stage number match.

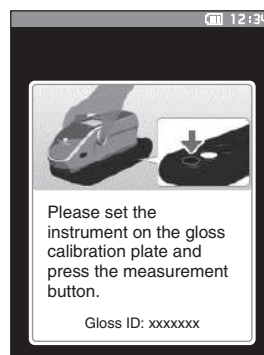
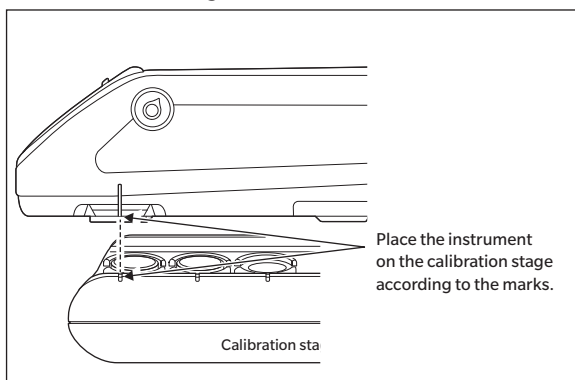

6 Press the measurement button.

Gloss calibration will be performed.

- Notes**
- Do not move the instrument until gloss calibration is complete.

When gloss calibration is completed, the screen returns to the <Sample> screen.



■ User calibration

You can perform calibration by using your own reference plate and calibration data instead of white calibration. The calibration data for user calibration can be specified by connecting the instrument to a computer and using the optional Color Data Software "SpectraMagic NX2". Select whether to use the user calibration data for measurement with <Calibration setup> - <User calibration> (refer to P.140) on the instrument.

Operating Procedure

Start the procedure from the measurement screen.

1 Perform user calibration instead of white calibration.

Notes Before user calibration can be set to ON, user calibration data must be prepared and written to the instrument memory from a computer.

2 Set the instrument on the user tile so that the measuring port is over the tile.



3 Press the measurement button.

User calibration will be performed. When user calibration is completed, the screen returns to the one displayed before the <Calibration> screen.



Setting a Specimen

Refer to P.33 for preparations to perform before measurement according to the specimen being measured and the application.

1. Switch the measurement area (CM-26dG/CM-26d).
2. Replace the target mask (CM-26d).
3. Set the instrument on top of the specimen.

■ Viewfinder

Switching the measurement area allows users to check the measurement point of a specimen when aligning the instrument and the target are necessary, such as when the measurement location is small.

How to Use

- 1 Set the instrument on top of the specimen.
- 2 Slide the viewfinder lever to open the viewfinder.

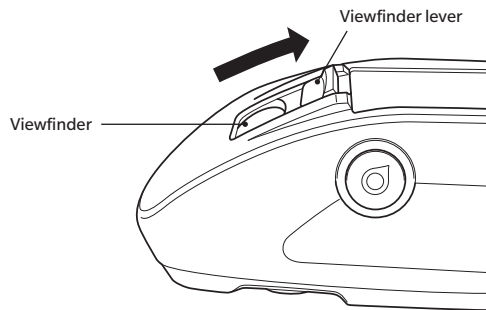

- 3 As the viewfinder opens, a white LED will turn ON, illuminating the specimen within the range of measurement.

Memo When using the CM-26dG, the range of measurement will be illuminated according to the set measurement area (MAV/SAV) when the measurement button is pressed.

- 4 Look into the viewfinder and adjust the position of the specimen.

- 5 Close the viewfinder. (The white LED will turn OFF.)

Notes If the reflectance of the specimen to be measured is low, the measurement range may not be clearly visible even when illuminated by a white LED. Also, if the specimen has a mirror surface or a surface similar to a mirror surface, the illumination light may not be clearly visible. In such cases, use the optional stapler type target mask (CM-A268).

Measurement

Notes

- Prior to the start of measurement, be sure to perform white calibration. For details, refer to “White Calibration and Gloss Calibration” on P.37.
- To display the color difference, color difference target must be set before measurement.
- To measure a target, select the target number before measurement.
- For accurate measurements, measure under the same conditions (surrounding temperature, etc.).

Operating Procedure

1 Press [◊/↗] to bring up the [Target] or [Sample] screen, depending on the objective.

The <Target> screen or the <Sample> screen is displayed.

Note: If the menu screen is displayed, press [ESC] and perform the operation after the Results Display screen is displayed.

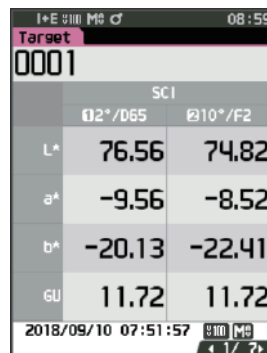

Target		
0001		
SCI		
	D2°/D65	D10°/F2
L*	76.56	74.82
a*	-9.56	-8.52
b*	-20.13	-22.41
GU	11.72	11.72

2018/09/10 07:51:57

2 Set the specimen measuring port on the sample to measure.

- Take care to prevent floating or tilting from occurring.
- Using the optional stapler type target mask (CM-A268) makes it possible to determine the measurement position more accurately.

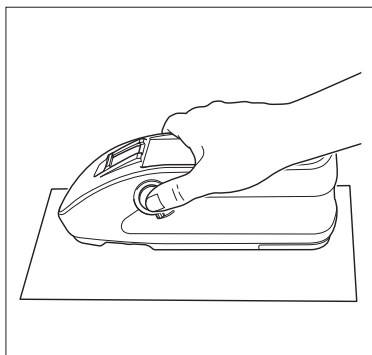
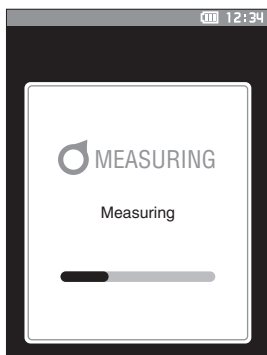

To measure concave surfaces, as shown in the following figure, use the standard accessory flat type battery cover (CM-A218).

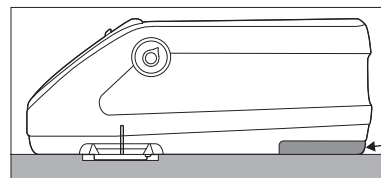

3 Press the measurement button.

The specimen is measured and the results are displayed on the screen.

- The selected number will be used as the target data number. If data is already present for that number, a confirmation dialog will ask if the data should be overwritten. Press the [Confirmation] key to overwrite.
- The sample No. is automatically assigned sequentially in the order of measurements.

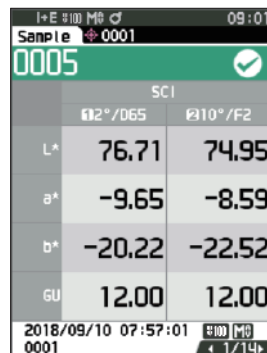

Sample		
0005		
SCI		
	D2°/D65	D10°/F2
L*	76.71	74.95
a*	-9.65	-8.59
b*	-20.22	-22.52
GU	12.00	12.00

2018/09/10 07:57:01

Memo

- When the number of sample data sets stored in the memory reaches 5,100, “The device memory is full. Please delete some data to measure.” will be displayed, indicating that some data sets must be deleted before measurement is possible.

■ Displaying the Measurement Results

At the end of measurement, the measurement results will be displayed on the LCD according to the specified conditions. Typical measurement result screens are shown below.

- Memo** You can switch the tab of the measurement screen with the ◀ or ▶ of the cross key.
 You can switch the sample No. with the ▲ or ▼.
 No GU value is displayed with CM-26d/CM-25d.

□ <Sample> detail screen: Absolute value

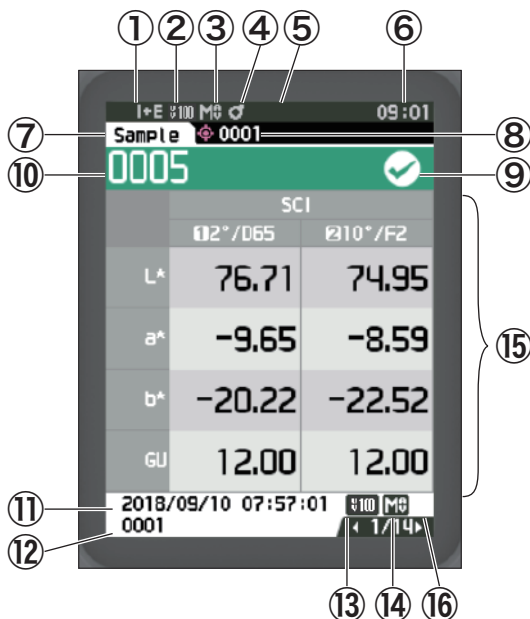

- ① Specular component mode used for the measurement
 - ② Current UV setting (not shown when set to UV 0%)
 - ③ Current measurement area
 - ④ Calibration completed
 - ⑤ Automatic printing from serial printer set to ON (OFF when the icon is not displayed)
 - ⑥ Current time
- * For details of the status bar items ① to ⑥, refer to P.23.
- ⑦ Target/Sample
 - ⑧ No. of the currently selected color difference target data
 - ⑨ Pass/fail judgment (When the result is "Pass", the background is shown in green. When the result is "Fail", the background is shown in orange.)
 - ⑩ Sample No.
 - ⑪ Date and time of the measurement
 - ⑫ Data No. of the color difference target data used for the measurement
 - ⑬ UV setting used for the measurement
 - ⑭ Measurement area used for the measurement
 - ⑮ Sample data (Use ◀ or ▶ to switch tabs)
 - ⑯ An exclamation mark (!) will be displayed for measurements that are beyond the guaranteed range or when measurement is performed even though a light intensity decrease warning or measurement out-of-range warning has occurred.

☐ <Sample> detail screen: “Difference” tab

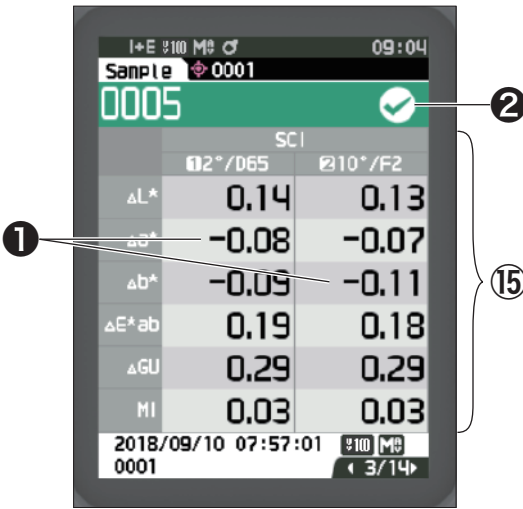

⑮ Sample data

(Use ◀ or ▶ to switch tabs)

- ① Any color difference value which failed the pass/fail judgment based on the tolerance will be highlighted in red.
- ② Pass/Fail:
 - Pass: The background is shown in green and “✓” is displayed.
 - Warning: The background is shown in yellow and “✓” is displayed as the result nears “Fail”.
 - Fail: The background is shown in orange and “×” is displayed.

☐ <Sample> detail screen: “Abs. & Diff.” Tab

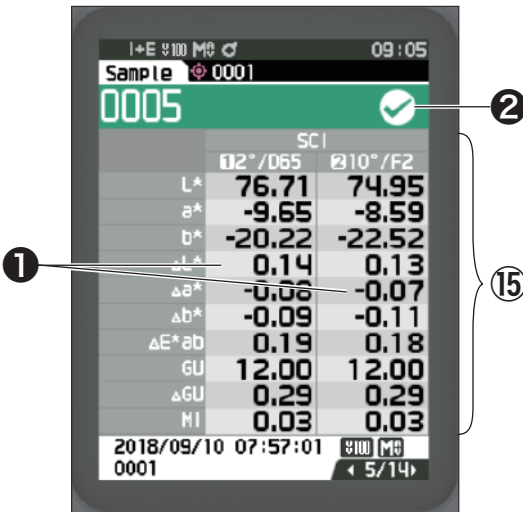

⑮ Sample data

(Use ◀ or ▶ to switch tabs)

- The left side shows the sample data measured with illuminant 1, and the right side shows the sample data measured with illuminant 2. If illuminant 2 has not been set, the right side will be blank.
- ① Any color difference value which failed the pass/fail judgment based on the tolerance will be highlighted in red.
 - ② Pass/Fail:
 - Pass: The background is shown in green and “✓” is displayed.
 - Warning: The background is shown in yellow and “✓” is displayed as the result nears “Fail”.
 - Fail: The background is shown in orange and “×” is displayed.

☐ <Sample> detail screen: “Pass/Fail” tab

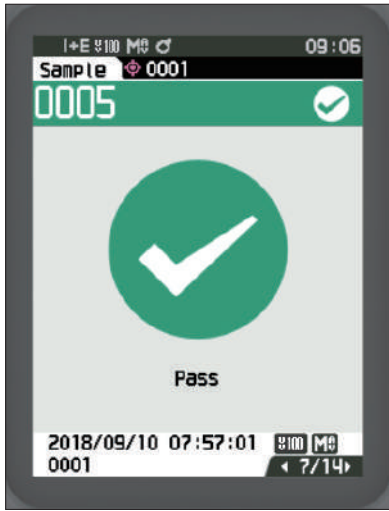

Pass/Fail:

- Pass: The background is shown in green and “✓ Pass” is displayed.
- Warning: The background is shown in yellow and “✓ Warning” is displayed as the result nears “Fail”.
- Fail: The background is shown in orange and “× Fail” is displayed.

☐ <Sample> detail screen: “Custom” tab

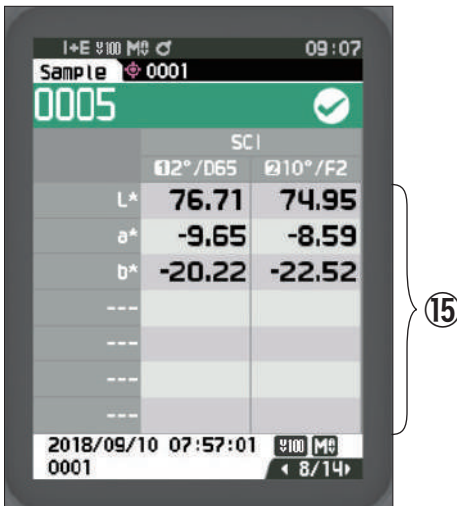

⑮ Sample data

(Use ◀ or ▶ to switch tabs)

- This tab is displayed when the display setting of “Custom” is set to ON. For the procedure of setting “Show Custom Data Screen” to ON/OFF, refer to P.107.

Memo

To set the items displayed on the “Custom” screen, you need to use the optional accessory Color Data Software SpectraMagic NX2. For details, refer to the instruction manual of SpectraMagic NX2.

☐ <Sample> detail screen: “Abs. Graph” Tab

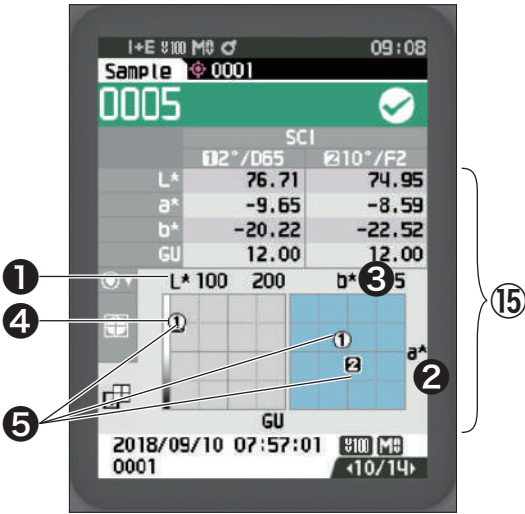

- ⑮ Sample data
(Use ◀ or ▶ to switch tabs)
- ① L* axis (colorimetric graph)
- ② a* axis (colorimetric graph)
- ③ b* axis (colorimetric graph)
- ④ Scales for the axes
- ⑤ Color difference target measurement point

☐ <Sample> detail screen: “Diff. Graph” Tab

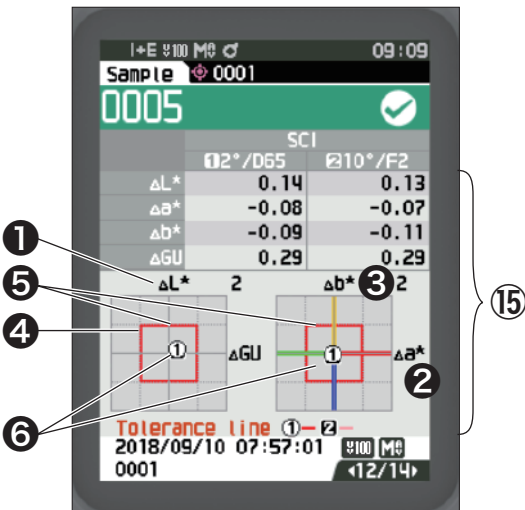

- ⑮ Sample data
(Use ◀ or ▶ to switch tabs)
- ① ΔL* axis (color difference graph)
- ② Δa* axis (color difference graph)
- ③ Δb* axis (color difference graph)
- ④ Color difference tolerance
- ⑤ Measurement point: Plotted with a light-blue circle (○).
- ⑥ Color difference target measurement point: This is the origin point of the graph.

Notes The measuring point will not be shown on the graph when no color difference target is set for the sample data.

□ <Sample> detail screen: “Spectral Graph” tab

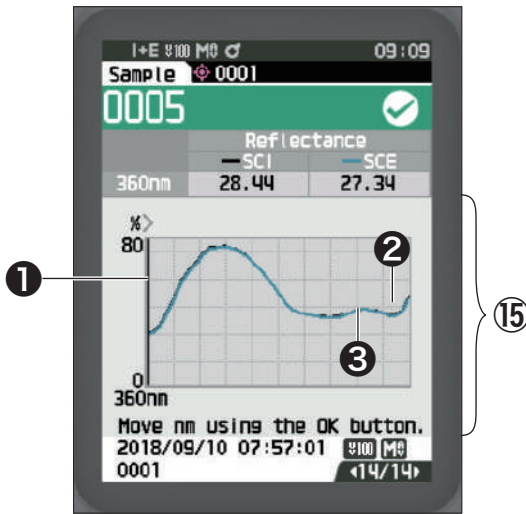

- ⑮ Sample data
(Use ◀ or ▶ to switch tabs)
- ① Axis of spectral reflectance
- ② Spectral graph of sample (SCI):
Shown with a solid black line.
- ③ Spectral graph of sample (SCE):
Shown with a solid blue line.

□ <Sample> List Screen

Every time the [ESC] key is pressed, the screen is switched between the <Sample> detail screen and <Sample> list screen.

Memo Measurement can be performed on either the <Sample> detail screen or <Sample> list screen.

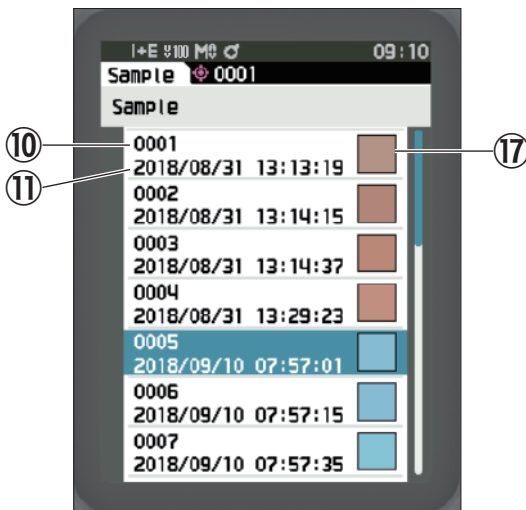

- ⑩ Sample No.
- ⑪ Date and time of the measurement
- ⑰ Pseudocolor expressing the sample data is displayed.

Screen transition

The detail screen is displayed only for screens with the appropriate format selected under <Display type>.

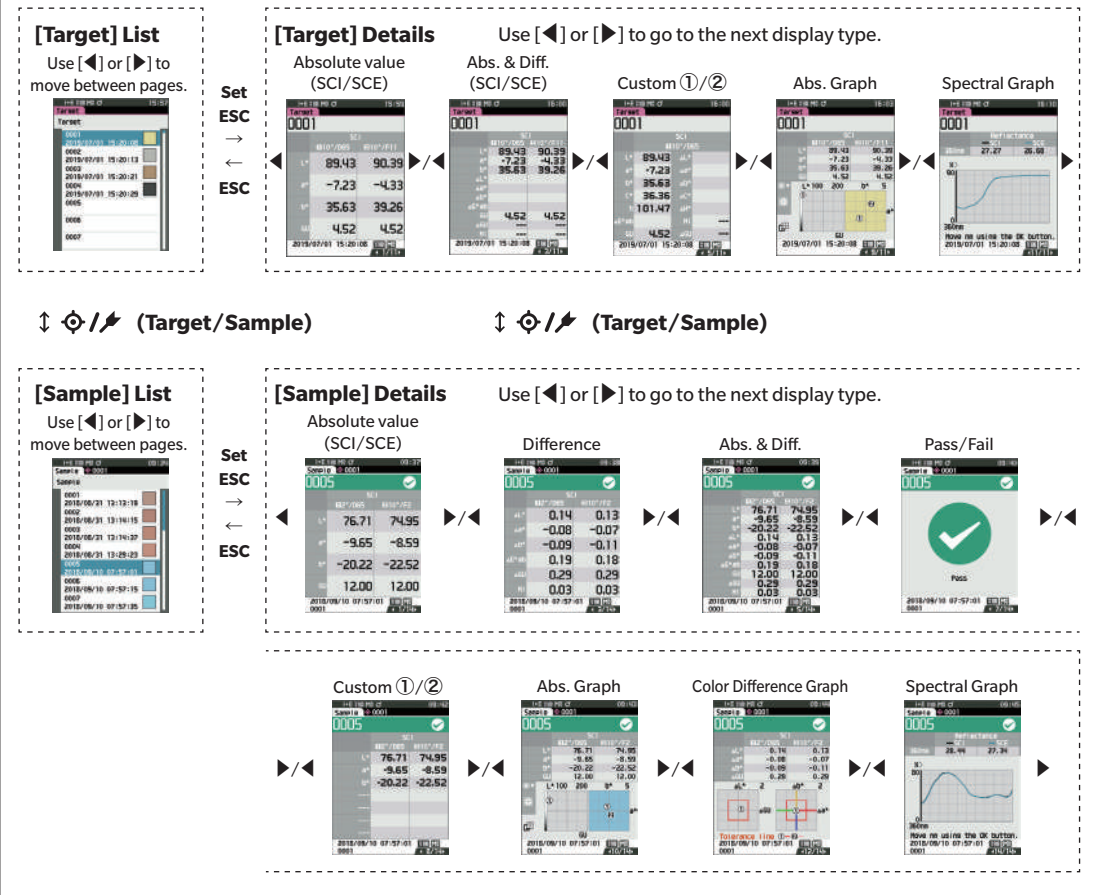

Measurement (Simple Mode)

Used to easily confirm color differences. The menu items that can be set in Simple mode are as follows.

Setting Procedure

1 Set to "Simple mode".

Press [ESC] to skip the calibration displayed immediately after turning the power ON.

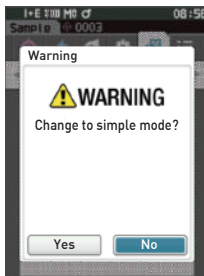
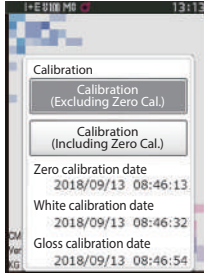

When "Change to simple mode?" appears on the screen, select "Yes".

Set "Simple mode" under <Setting> - <Instrument Mode>.

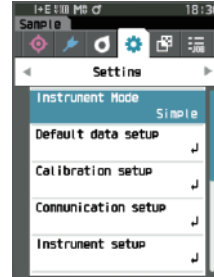

Press the [Target/Sample] key or the [ESC] key to switch to the Simple Measurement screen.

2 Measuring a target: Absolute value measurement

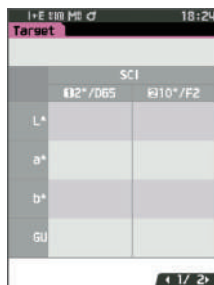

Press the measurement button.

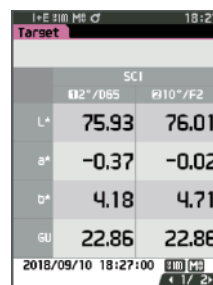

3 Measuring a sample: Difference measurement

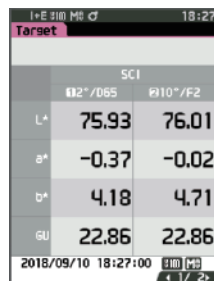

Press the measurement button.

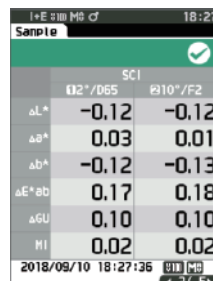

- Notes**
- Data is not saved when measuring in Simple mode.
 - Opacity mode cannot be selected while in Simple mode. In addition, Simple mode cannot be selected while in Opacity mode.

4 Press the measurement button to continue measuring color differences. To change the target, press [Target/Sample] to measure the target again.

Memo

To exit Simple mode, turn the instrument OFF or select "Normal" under [MENU] - <Settings> - <Instrument setup>.

Handling the Sample

The <Sample menu> screen allows the following operations for the sample.

<Print data> Print the current sample with the printer.

<Edit name> Name the sample.

<Data management>

- Delete data : Delete the selected sample.
- Set Sample as Target : Set sample as target data.
- Change Target reference : Change target reference.
- Change list position : Jump to the specified sample.
- Delete all data : Delete all samples.

<Auto target> During measurement, the color difference target with the smallest color difference value is automatically selected.

Setting Procedure

Start the procedure from the measurement screen.

- 1 Press [MENU], and then use [◀] or [▶] to display the <Sample menu> screen.

Memo To return to the previous screen, press [MENU] or [ESC].

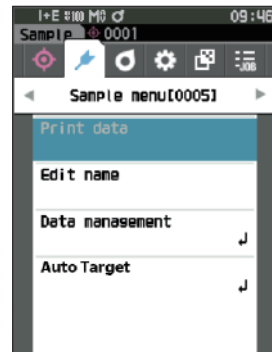

■ Print Data (Sample)

Print the sample. The instrument must be connected to the serial printer in advance. For instructions on how to connect the instrument to a serial printer, refer to P.131 “Connecting to a Printer/Barcode Reader”.

- Notes**
- Display the sample to be printed on the <Sample> screen in advance.
 - If a proper connection is not established, printing will not be possible.
 - Even if the printer is connected correctly, printing may not be possible under some circumstances, such as if the printer is turned OFF when printing.

Display the sample to be printed on the <Sample> screen in advance.

Setting Procedure

Start the procedure from the <Sample menu> screen.

- 1 Use [▲] or [▼] to move the cursor to “Print data”, and press the [Confirmation] key to display the <Print data> screen. Printing will begin from the connected printer.

When printing is complete, the screen returns to the <Sample> screen.

- Notes**
- The <Print data> screen is displayed even when data will not be printed properly due to an improper printer connection or other problem.

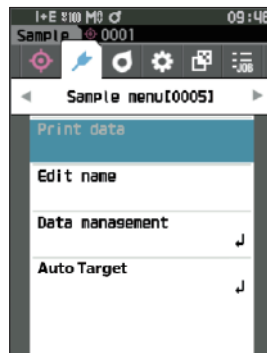

■ Edit name

Name the sample.

Display the name of the sample to be edited on the <Sample> screen in advance.

Setting Procedure

Start the procedure from the <Sample menu> screen.

- 1 Use [▲] or [▼] to move the cursor to “Edit name”, and then press the [Confirmation] key.
The <Edit name> screen is displayed.

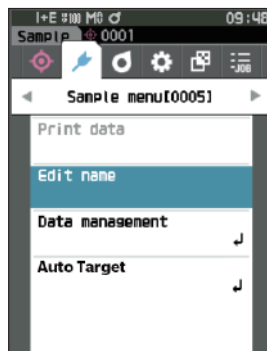

- 2 Use [▲]/[▼] or [◀]/[▶] to move the cursor between characters, and then press the [Confirmation] key.

- Up to 30 characters can be used.
- The selected character is displayed in the text box.
- If the name is obtained from the barcode reader, the name will be set as the name for the sample.

- 3 Repeat step 2 until the necessary characters have been entered.

- To delete the character to the left of the cursor in the text box, move the cursor to [×] and press the [Confirmation] key.



- 4 After inputting the characters, move the cursor to [OK] and press the [Confirmation] key.

The setting is confirmed and the screen returns to the <Sample> screen.

Memo

- If [ESC] is pressed during configuration, or if the cursor is moved to “Cancel” and the [Confirmation] key is pressed, the settings will not be changed and the screen will return to the <Sample menu> screen.
- When using a barcode reader, barcodes can be used on the <Edit name> screen. Refer to P.131 to P.133 “Connecting to a Printer/Barcode Reader” for information on connecting a barcode reader.

■ Data Management (Sample)

Sample data management allows users to delete a sample, copy the sample to the target, change the link to the target, change the list position, and delete all data.

Setting Procedure

Start the procedure from the <Sample menu> screen.

- 1 Use [▲] or [▼] to move the cursor to “Data management”, and then press the [Confirmation] key to display the <Data management> screen.

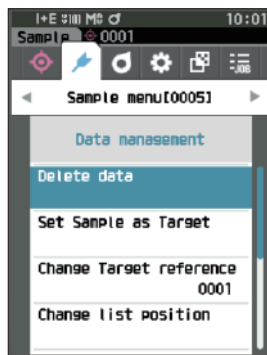
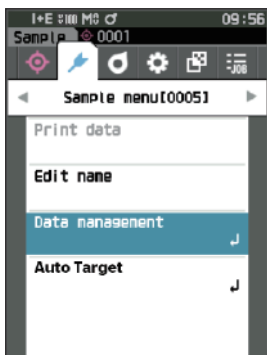

□ Delete

Delete the sample.

Display the sample to be deleted on the <Sample> screen in advance.

Setting Procedure

Start the procedure from the <Sample menu> - <Data management> screen.

- 1 Use [▲] or [▼] to move the cursor to “Delete data”, and then press the [Confirmation] key. The <Delete data> screen is displayed.
- 2 Use [◀] or [▶] to move the cursor to “OK” and press the [Confirmation] key to delete.

Memo When data is deleted, the subsequent sample data numbers will be reassigned, reducing each by one.

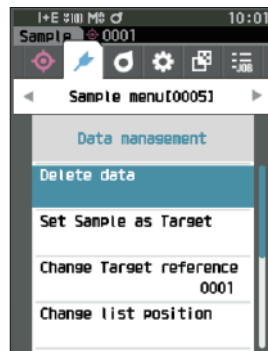

- When the deletion is complete, the screen returns to the <Sample> screen.
- Moving the cursor to “Cancel” and pressing the [Confirmation] key will cancel the deletion, and the screen will return to the <Data management> screen.



□ Set Sample as Target

Sample data can be copied to target data and registered.
 Display the sample to be set as the target on the <Sample> screen in advance.

Setting Procedure

Start the procedure from the <Sample menu> - <Data management> screen.

- Memo**
- Color difference targets are stored with setting numbers from 0001 to 2500 being assigned. Even if the data at some point is deleted, these setting numbers do not change. It is useful to group data by assigning numbers of specific digits.
 - To set more accurate color difference target data, use average measurement to measure the target specimen. For details, refer to the section on average measurement (P.94 and 95).

- Notes**
- **Unlike with samples, the numbers assigned to color difference target data do not change automatically. When measuring colors continuously to set color difference targets, the cursor must be moved manually to set each data.**
 - **This function cannot be used if the target is protected or if the filter is enabled.**

- 1 Use [▲] or [▼] to move the cursor to “Set Sample as Target”, and then press the [Confirmation] key. The <Set Sample as Target> screen is displayed.

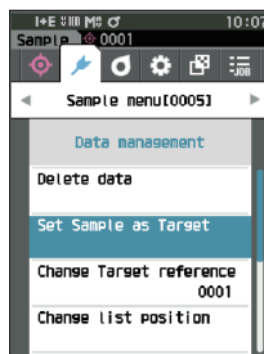

- 2 The target data number being used will be displayed. Use [▲] or [▼] to move the cursor to the color difference target number, and then press the [Confirmation] key. When the target data is set, the screen returns to the <Target> screen.

- If [ESC] is pressed without pressing the [Confirmation] key, the screen will return to the <Target> screen.



- Notes**
- If a number to which color difference target data has already been set is selected, a message is displayed to confirm overwriting. Use [◀] or [▶] to select “OK”, and then press the [Confirmation] key. Moving the cursor to “Cancel” and pressing the [Confirmation] key will cancel the deletion, and the screen will return to the <Data management> screen.



□ Change Target Reference

The target data acting as a reference for the sample can be changed.

Display the sample for which the target reference is to be changed on the <Sample> screen in advance.

Setting Procedure

Start the procedure from the <Sample menu> - <Data management> screen.

- 1 Use [▲] or [▼] to move the cursor to “Change Target reference”, and then press the [Confirmation] key. The <Change Target reference> screen is displayed.

Notes

- If a target with different measurement conditions is specified, an error message will be displayed. Change to a target with the same measurement conditions.

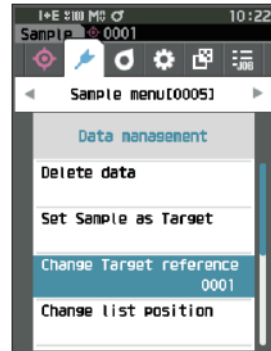

- 2 The target data number being used will be displayed. Use [▲] or [▼] to move the cursor to the color difference target number, and then press the [Confirmation] key. When the target data is set, the screen returns to the <Sample> screen.

- If [ESC] is pressed, the target changes will not be applied and the screen will return to the <Data management> screen.

Notes

- If a number to which no color difference target data has been set, the target will be determined as “None” and the color difference and pass/fail judgment will not be displayed.



□ Change list position

Specifying sample numbers allows for specified sample to be selected without the need to scroll the screen.

Setting Procedure

Start the procedure from the <Sample menu> - <Data management> screen.

- 1 Use [▲] or [▼] to move the cursor to “Change list position”, and then press the [Confirmation] key. The <Change list position> screen is displayed.

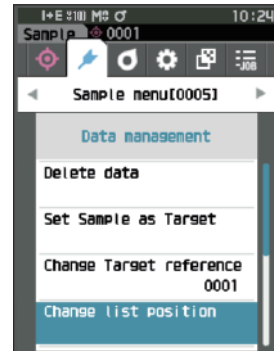

- 2 ▲ and ▼ will be displayed above and below the data number. Use [▲] or [▼] to specify a value. Use [◀] or [▶] to move between digits.

- 3 Press the [Confirmation] key. The selection is confirmed and the screen returns to the <Sample> screen.

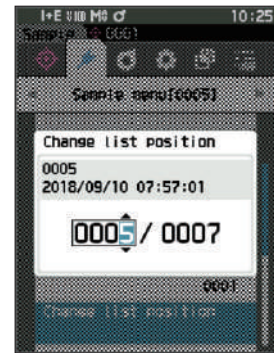

Notes If [ESC] is pressed without pressing the [Confirmation] key, the settings will not be changed and the screen will return to the <Data management> screen.

Notes Numbers with no measurement data cannot be selected.

□ Delete All Data (Sample)

Delete all samples.

Setting Procedure

Start the procedure from the <Sample menu> - <Data management> screen.

- 1 Use [▲] or [▼] to move the cursor to “Delete all data”, and then press the [Confirmation] key.

The <Delete all data> screen is displayed.

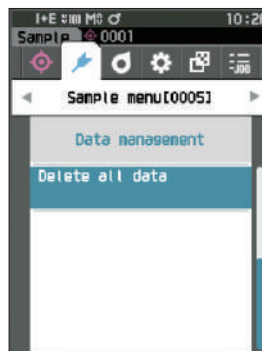

- 2 Use [◀] or [▶] to move the cursor to “OK” and press the [Confirmation] key to delete all data.

- When the deletion is complete, the screen returns to the <Sample> screen.
- Moving the cursor to “Cancel” and pressing the [Confirmation] key will cancel the deletion of all data, and the screen will return to the <Data management> screen.



■ Auto Target (Sample)

During measurement, the color difference target with the smallest color difference value is automatically selected. Color difference targets with a smaller color difference value than the preset threshold are displayed in ascending order from the target with the smallest color difference. The color difference target to use can be selected from among the displayed targets. If only one color difference target has a color difference value less than the threshold, that color difference target will be automatically selected.

Memo The color difference is calculated using the color difference equation set for the instrument.

- Notes**
- Do not use this function to manage the color difference from a specific target.
 - This function is not applied to sample data obtained before the function was turned ON.

Setting Procedure

Start the procedure from the <Sample menu> screen.

- 1 Use [▲] or [▼] to move the cursor to “Auto Target”, and then press the [Confirmation] key to display the <Auto Target> screen.

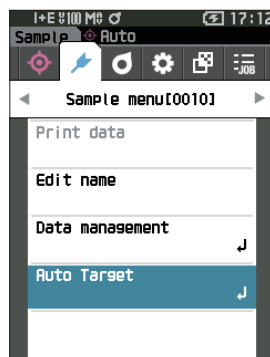

□ Auto Target (Sample)

Setting Procedure

Start the procedure from the <Sample menu> - <Auto Target> screen.

- 1 Use [▲] or [▼] to move the cursor to “Auto Target”, and then press the [Confirmation] key. The <Auto Target> screen is displayed.

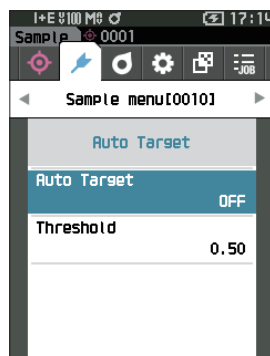

2 Use [▲] or [▼] to move the cursor to “ON” or “OFF”.

Settings

- ON : The automatic target selection function will be used.
- OFF : The automatic target selection function will not be used.

3 Press the [Confirmation] key.

The selection is confirmed and the screen returns to the <Auto Target> screen.

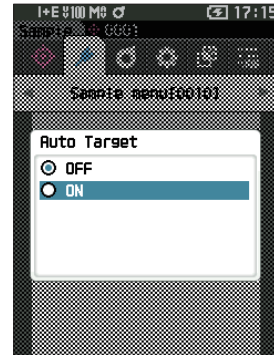

□ Threshold (Sample)

Sets the threshold to be used for the automatic target selection function.

Setting Procedure

Start the procedure from the <Sample menu> - <Auto Target> screen.

1 Use [▲] or [▼] to move the cursor to “Threshold”, and then press the [Confirmation] key.

The <Threshold> screen is displayed.



2 ▲ and ▼ are displayed above and below the number to be set.

Use [▲] or [▼] to specify a value.

Settings

- 0.01 to 9.99

3 Press the [Confirmation] key.

The selection is confirmed and the screen returns to the <Auto Target> screen.

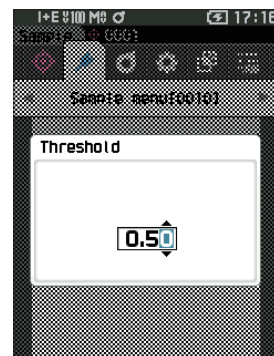

Notes If [ESC] is pressed without pressing the [Confirmation] key, the settings will not be changed and the screen will return to the <Auto Target> screen.

Pass/Fail Judgment for Color Difference

With this instrument, tolerances can be set for the color difference target of the sample to perform judgment. For the procedure on setting tolerances, refer to P.72 “Tolerance Settings” and P.81 “Default Tolerance Settings”.

If color difference target data is deleted, neither the color difference display for the data nor the pass/fail judgment based on the tolerances set to the data will be performed. If other color difference target data is selected, or another color difference target is assigned to the color difference target number of the deleted data, recalculations and pass/fail judgments will be performed.

■ Pass/Fail Judgment Based on Tolerances

If the measured color difference is outside the tolerances set for the color difference target, the value will be highlighted in red to indicate that the judgment result is “Fail”. By setting the warning level (P.82), even if the sample does not exceed the tolerance, that item will be highlighted with the warning color and a warning will be issued if the sample nears the tolerance. Both maximum and minimum tolerances can be set for each color difference target.

Pass/fail judgments based on tolerances are displayed as follows.

Notes Before using this function, the tolerances must be set.

<Sample> display screen

Notes If no relevant target data has been set, no color difference value or pass/fail mark will be displayed.

○ Display when all color differences and gloss value differences do not exceed or near the tolerance

Absolute value, Difference, Abs. & Diff., and Custom screens

Ex.: Abs. & Diff. screen

	12"/D65	10"/F2
L*	76.71	74.95
a*	-9.65	-8.59
b*	-20.22	-22.52
ΔL*	0.14	0.13
Δa*	-0.08	-0.07
Δb*	-0.09	-0.11
ΔE*ab	0.19	0.18
GU	12.00	12.00
ΔGU	0.29	0.29
HI	0.03	0.03

← Mark signifying a "Pass" judgment

Pass/Fail screen

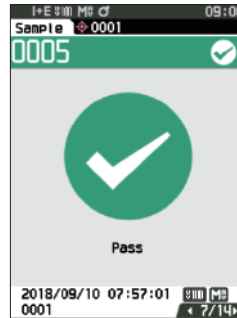

"PASS" is printed in the print output.

The pass mark and "Pass" are displayed.

○ Display when any color difference or gloss value difference nears the tolerance

Absolute value, Difference, Abs. & Diff., and Custom screens

Ex.: Abs. & Diff. screen

	12"/D65	10"/F2
L*	76.78	74.99
a*	-10.18	-8.99
b*	-20.21	-22.56
ΔL*	0.21	0.17
Δa*	-0.62	-0.47
Δb*	-0.08	-0.15
ΔE*ab	0.66	0.52
GU	10.76	10.76
ΔGU	-0.95	-0.95
HI	0.17	0.17

← The pass judgment mark and the background color are changed to yellow.

← The background of any value close to the tolerance is changed to yellow.

Pass/Fail screen

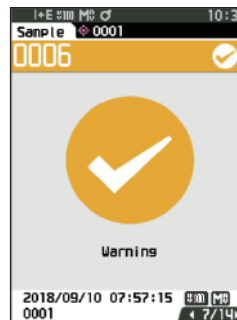

"WARN" is printed in the print output, and "w" is appended after any value near the tolerance.

"Warning" is displayed, and the mark changes to yellow.

○ Display when any color difference or gloss value difference exceeds the tolerance

Absolute value, Difference, Abs. & Diff., and Custom screens

Ex.: Abs. & Diff. screen

	12"/D65	10"/F2
L*	78.51	76.46
a*	-13.42	-11.57
b*	-18.75	-21.42
ΔL*	1.94	1.64
Δa*	-3.86	-3.05
Δb*	1.38	0.99
ΔE*ab	4.53	3.60
GU	18.83	18.83
ΔGU	7.11	7.11
HI	0.95	0.95

← The fail judgment mark and the background color are changed to orange.

← The background of any value that exceeds the tolerance is changed to orange.

Pass/Fail screen

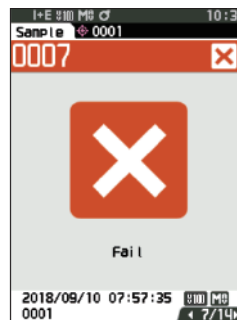

"FAIL" is printed in the print output, and "x" is appended after any value that exceeds the tolerance.

An orange fail mark and "Fail" are displayed.

Color Difference Target Operation

To measure the color difference between two specimens, the color of one of the specimens must be set as the color difference target. This instrument can store up to 1,000 targets and 5,100 samples.

Memo

- Color difference target data is stored with setting numbers from 0001 to 1000 being assigned. Even if the data at some point is deleted, these setting numbers do not change. It is useful to group data by assigning numbers of specific digits.
- To set more accurate color difference target data, use average measurement to measure the target specimen. For details, refer to the section on average measurement (P.94 and 95).

Notes

- Be sure to perform white calibration before setting color difference targets.
- To ensure measurement accuracy, make sure to keep ambient conditions (temperature, etc.) constant.

The **<Target menu>** screen allows the following operations for target data.

<Print data>

Print the current target data with the printer.

<Edit name>

Name the target data.

<Data management>

- Delete data : Delete the selected target data.
- Set group : Configure the target group.
- Change list position : Jump to the specified target data.
- Edit Target filter : Displays the target data that meets the specified conditions.
- Protect data : Protects all target data. New measurements are still possible.
- Delete all data : Deletes all of the target data.

<Input Colorimetric data>

Set the target by numerical input.

Operating Procedure

Start the procedure from the measurement screen.

- 1 Press [MENU], and then use [◀] or [▶] to display the **<Target menu>** screen.

Memo

To return to the **previous screen**, press [MENU] or [ESC].

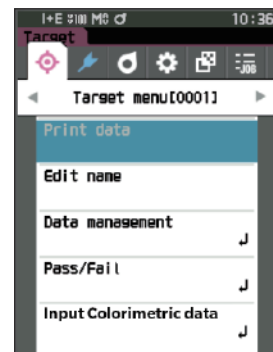

■ Print Data (Target)

Print the target data. The instrument must be connected to the serial printer in advance. For instructions on how to connect the instrument to a serial printer, refer to P.131 "Printer Connection".

- Notes**
- Display the target to be printed on the <Target> screen in advance.
 - If a proper connection is not established, printing will not be possible.
 - Even if the printer is connected correctly, printing may not be possible under some circumstances, such as if the printer is turned OFF when printing.

Operating Procedure

Start the procedure from the <Target menu> screen.

- 1 Use [▲] or [▼] to move the cursor to "Print data", and press the [Confirmation] key to display the <Print data> screen. Printing will begin from the connected printer.

When the printing is complete, the screen returns to the <Target> screen.

- Notes** The <Print data> screen is displayed even when data will not be printed properly due to an improper printer connection or other problem.



■ Edit name

Name the color difference target data.

Operating Procedure

Start the procedure from the <Target menu> screen.

- 1 Use [▲] or [▼] to move the cursor to “Edit name”, and then press the [Confirmation] key.

The <Edit name> screen is displayed.

- 2 Use [▲]/[▼] or [◀]/[▶] to move the cursor between characters, and then press the [Confirmation] key.

- Up to 30 characters can be used.
- The selected character is displayed in the text box.

- 3 Repeat step 2 until the necessary characters have been entered.

- To delete the character to the left of the cursor in the text box, move the cursor to [x] and press the [Confirmation] key.

- 4 After inputting the characters, move the cursor to [OK] and press the [Confirmation] key.

The setting is confirmed and the screen returns to the <Target> screen.

Memo

- If [ESC] is pressed during configuration, or if the cursor is moved to “Cancel” and the [Confirmation] key is pressed, the settings will not be changed and the screen will return to the <Target menu> screen.
- When using a barcode reader, barcodes can be used on the <Edit name> screen. Refer to P.131 to P.133 “Connecting to a Printer/Barcode Reader” for information on connecting a barcode reader.



■ Data Management (Target)

Target data management allows users to enforce target data restrictions, perform grouping, change list positions, edit target filters, protect data, and delete all data.

Operating Procedure

Start the procedure from the <Target menu> screen.

- 1 Use [▲] or [▼] to move the cursor to “Data management”, and then press the [Confirmation] key to display the <Data management> screen.

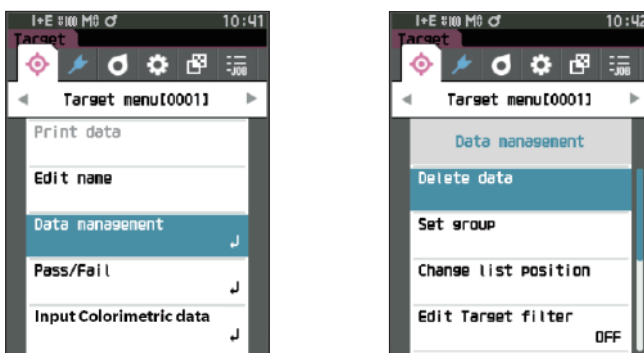

□ Delete

Delete the target data.

Display the target to be deleted on the <Target> screen in advance.

Operating Procedure

Start the procedure from the <Target menu> - <Data management> screen.

- 1 Use [▲] or [▼] to move the cursor to “Delete data”, and then press the [Confirmation] key. The <Delete data> screen is displayed.

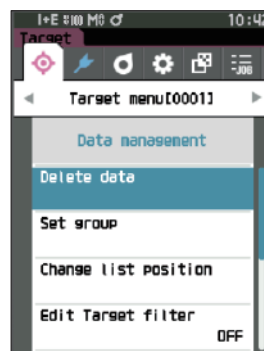

- 2 Use [◀] or [▶] to move the cursor to “OK” and press the [Confirmation] key to delete.

Memo Even if deletion is performed, numbers do not shift upward. That number for that measurement is instead left blank.

- When the deletion is complete, the screen returns to the <Target> screen.
- Moving the cursor to “Cancel” and pressing the [Confirmation] key will cancel the deletion, and the screen will return to the <Data management> screen.



□ Set group

In order to facilitate classification of targets into groups, up to five groups to which data should be categorized can be configured. After the targets have been registered to a group, the filtering function can be used to display only the selected target data. This section describes the registration of a group.

- Memo**
- If a new target is measured, the measurement will be assigned to the appropriate group according to the default settings.
 - Display the group of the target to be set on the <Target> screen in advance.

Operating Procedure

Start the procedure from the <Target menu> - <Data management> screen.

- 1 Use [▲] or [▼] to move the cursor to “Set group”, and then press the [Confirmation] key.

The <Edit group> screen is displayed.

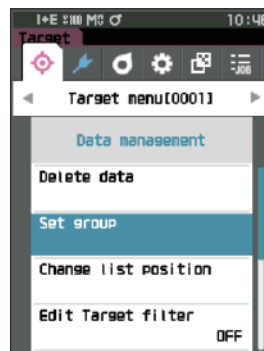

- 2 Use [▲] or [▼] to move to the cursor to the group number column to which the current target should be applied, and then press the [Confirmation] key.

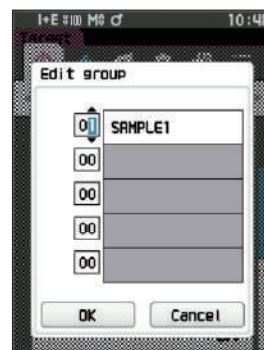

- 3 Use [▲] or [▼] to move the cursor to select the group value to which the target should be applied, and then press the [Confirmation] key.

The selection is confirmed and the screen returns to the <Target> screen.

- Memo**
- Group names configured in advance through <Default data setup> in accordance with group numbers are displayed.

- 4 Select “OK”. Selecting “Cancel” will cause the display to return to the <Data management> screen without changing the settings.

- Notes**
- If [ESC] is pressed without pressing the [Confirmation] key, the settings will not be changed and the screen will return to the <Data management> screen.

□ Change list position

Specifying target numbers allows for specified targets to be displayed without the need to scroll the screen.

Operating Procedure

Start the procedure from the <Target menu> - <Data management> screen.

- 1 Use [▲] or [▼] to move the cursor to “Change list position”, and then press the [Confirmation] key.
The <Change list position> screen is displayed.

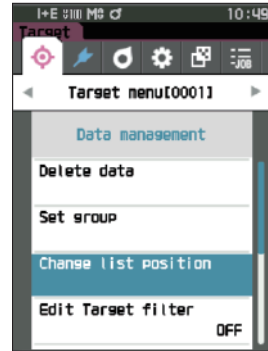

- 2 ▲ and ▼ will be displayed above and below the data number. Use [▲] or [▼] to specify a value. Use [◀] or [▶] to move between digits.

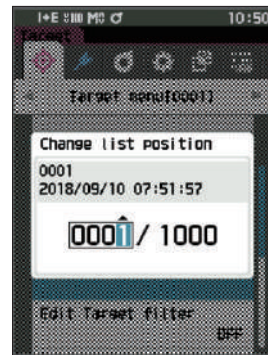

- 3 Press the [Confirmation] key.
The selection is confirmed and the screen returns to the <Target> screen.

Notes If [ESC] is pressed without pressing the [Confirmation] key, the settings will not be changed and the screen will return to the <Data management> screen.

□ Edit Target filter

The filter function makes searching for a target easier. The function allows only selected target data to be displayed by selecting only saved data or by selecting a group created in advance.

Memo The Edit Target filter is set to “OFF” when the instrument is shipped from the factory.

Operating Procedure

Start the procedure from the <Target menu> - <Data management> screen.

1 Use [▲] or [▼] to move the cursor to “Edit Target filter”, and then press the [Confirmation] key. The <Edit Target filter> screen is displayed.

2 Use [▲] or [▼] to move the cursor to the desired item.

Settings

- OFF : All target data will be displayed.
- only saved data : Displays only numbers for the saved target.
- only group : Only targets that satisfy all of the group conditions displayed below are displayed. Select and press the [Confirmation] key to display the group selection screen. With the cursor on the group numbers, press the [Confirmation] key. Using [▲] or [▼] to select the group number displays the group name set for the default group. Press the [Confirmation] key to confirm, move to [OK], and press the [Confirmation] key to return to the <Data management> screen.

3 Press the [Confirmation] key. (With [OFF] and [only saved data])

The selection is confirmed and the screen returns to the <Target> screen.

Notes If [ESC] is pressed without pressing the [Confirmation] key, the settings will not be changed and the screen will return to the <Data management> screen.

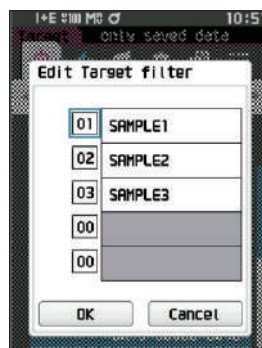
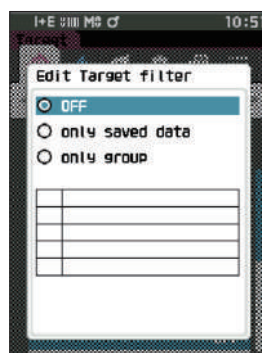
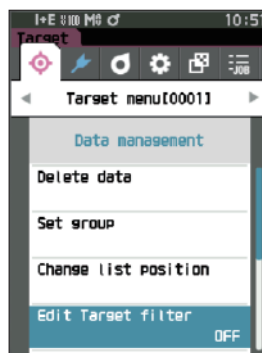

□ Data Protection

Data protection can be specified so that the saved target settings will not be deleted or changed by accident. When the data protection is set, some menu options relating to the target cannot be selected, and target overwrite measurement cannot be performed.

Memo Protect data is set to “OFF” when the instrument is shipped from the factory.

Operating Procedure

Start the procedure from the <Target menu> - <Data management> screen.

- 1 Use [▲] or [▼] to move the cursor to “Protect data”, and then press the [Confirmation] key.

The <Protect data> screen is displayed.

- 2 Use [▲] or [▼] to move the cursor to the desired item.

Settings

- OFF : Do not protect any data.
- ON : Protect all data.

- 3 Press the [Confirmation] key.

The selection is confirmed and the screen returns to the <Data management> screen. When protection is turned ON, the key icon indicating data protection is turned ON will be displayed in the status bar.

Notes If [ESC] is pressed without pressing the [Confirmation] key, the settings will not be changed and the screen will return to the <Data management> screen.



□ Delete All Data (Target)

Delete all the color difference target data that have been set.

Notes When the data is protected, “Delete all data” cannot be selected on the <Data management> screen.

Operating Procedure

Start the procedure from the <Target menu> - <Data management> screen.

- 1 Use [▲] or [▼] to move the cursor to “Delete all data”, and then press the [Confirmation] key.
The <Delete all data> screen is displayed.
- 2 Use [◀] or [▶] to move the cursor to “OK” and press the [Confirmation] key to delete all data.
 - When the deletion is complete, the screen returns to the <Target> screen.
 - Moving the cursor to “Cancel” and pressing the [Confirmation] key will cancel the deletion of all data, and the screen will return to the <Data management> screen.

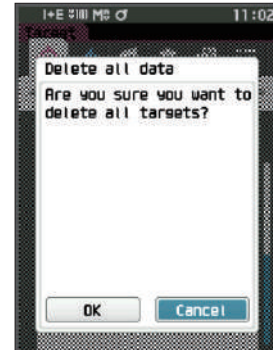
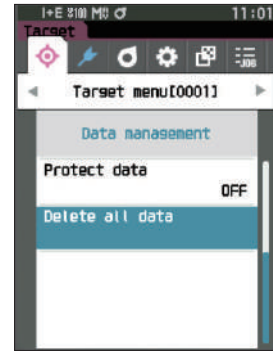

■ Pass/Fail

Edit the tolerance that will be used as the judgment criteria, and set the warning level and the parametric coefficient default value.

If the color difference between the sample and the target exceeds the tolerance, the column of the display color value relevant to the measurement display will be displayed in red. In addition, if even one display color value exceeds the tolerance, judgment will be shown as “Fail”.

If the color difference between the sample and the target exceeds the warning level amount, the column of the display color value relevant to the measurement display will be displayed in yellow. In such cases, even if other display color values do not exceed the tolerance, judgment will be shown as “Warning”.

Memo

- The default judgment criteria is set before judgment criteria for each target is set. For details, refer to P.79 “Default Data Settings”.
- The tolerance setting items are the same as those for the color space or index currently selected for the observation conditions.
- The optional Color Data Software “SpectraMagic NX2” allows for easy configuration and use of judgment criteria.
- Display the target to be set in advance before moving to <Target menu>.

Operating Procedure

Start the procedure from the <Target menu> screen.

- 1 Use [▲] or [▼] to move the cursor to “Pass/Fail”, and then press the [Confirmation] key to display the <Pass/Fail> screen.

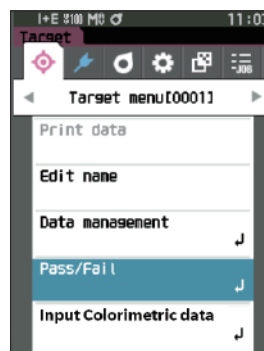

□ Tolerance Settings

Specify the tolerance used for pass/fail judgment of measured for each target.

Operating Procedure

Start the procedure from the <Target menu> - <Pass/Fail> screen.

- 1 Use [▲] or [▼] to move the cursor to “Edit tolerance”, and then press the [Confirmation] key.

The tolerance list screen is displayed.

- 2 Use [▲] or [▼] to move the cursor to the item to set, and then press the [Confirmation] key.

The <Edit tolerance> screen is displayed.

- 3 Use [▲]/[▼] and [◀]/[▶] to move the cursor to the item to set, and then press the [Confirmation] key to change the setting.

- When the selected item is not currently checked, pressing the [Confirmation] key causes the item to be checked, after which the setting value can be changed.
- Press [◀] or [▶] to move the cursor to the setting value area. Pressing the [Confirmation] key causes the cursor to appear on the value. Press [▲] or [▼] to change the value. Move the cursor between the digits of the value by pressing [◀] or [▶].

Settings

- x / y : -0.2000 to 0.2000
- Equation / MI : 0.00 to 20.00
- Other than the above : -20.00 to 20.00
- Press the [Confirmation] key to confirm every time the setting of an item is changed.

- 4 After all settings have been configured, use [▲] or [▼] to move the cursor to “OK”, and then press the [Confirmation] key.

The setting is confirmed and the screen returns to the <Pass/Fail> screen.

Pressing the [ESC] while configuring the settings will prevent the settings on the currently opened screen from being applied and revert all settings to the previous condition.

- 5 Press [ESC] to return to the <Pass/Fail> screen.

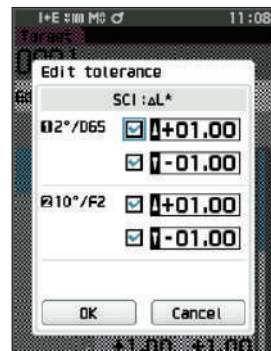
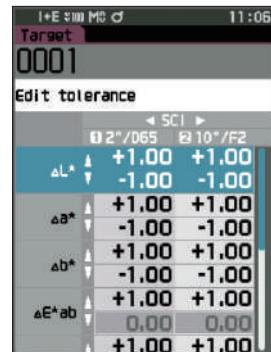
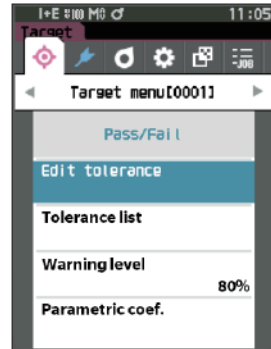

□ Tolerance List

Select the index used for sample pass/fail judgment.

Operating Procedure

Start the procedure from the <Target menu> - <Pass/Fail> screen.

- 1 Use [▲] or [▼] to move the cursor to “Tolerance list”, and then press the [Confirmation] key.

The available tolerances are displayed.



- 2 Use [▲] or [▼] to move the cursor to the item to set, and then press the [Confirmation] key.

- When the selected item is not currently checked, pressing the [Confirmation] key causes the item to be checked. When the selected item is currently checked, pressing the [Confirmation] key causes the item to be unchecked.
- Up to 14 indexes can be selected.

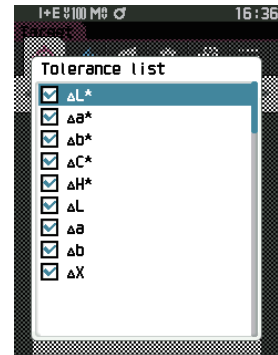

- 3 After all settings have been configured, use [▲] or [▼] to move the cursor to “OK”, and then press the [Confirmation] key.

The setting is confirmed and the screen returns to the <Pass/Fail> screen.

Pressing the [ESC] while configuring the settings will prevent the settings on the currently opened screen from being applied and revert all settings to the previous condition.

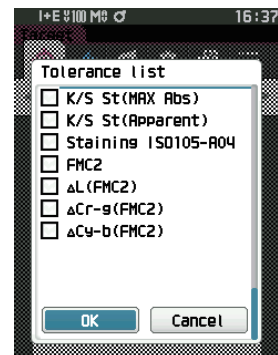

- 4 Press [ESC] to return to the <Pass/Fail> screen.

□ Warning Level Setting

When a warning level is set, warnings will be displayed when the measured data nears but does not exceed the tolerance.

Operating Procedure

Start the procedure from the <Target menu> - <Pass/Fail> screen.

1 Use [▲] or [▼] to move the cursor to “Warning level”, and then press the [Confirmation] key.
The <Warning level> screen is displayed.

2 Use [▲] or [▼] to change the value.

Settings

○ 000 to 100%

3 Press the [Confirmation] key after completing the changes.

The setting is confirmed and the screen returns to the <Pass/Fail> screen.

Notes If [ESC] is pressed during configuration, the settings will not be changed and the screen will return to the <Pass/Fail> screen.

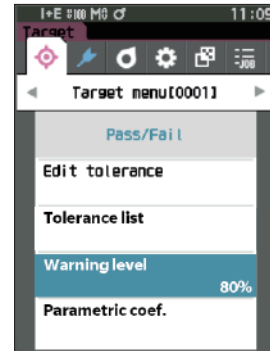

□ Parametric Coefficient Setting

Specify the parametric coefficient used for pass/fail judgment of a sample for each target.

Operating Procedure

Start the procedure from the <Target menu> - <Pass/Fail> screen.

- 1 Use [▲] or [▼] to move the cursor to “Parametric coef.,” and then press the [Confirmation] key.
The <Parametric coef.> screen is displayed.

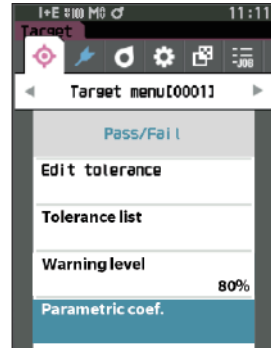

- 2 Use [▲] or [▼] to move the cursor to the item to set, and then press the [Confirmation] key.
The <Parametric coef.> edit screen is displayed.

- 3 Use [▲] or [▼] to move the cursor to the item to set, and press the [Confirmation] key to change the setting.

- Pressing the [Confirmation] key causes the cursor to appear on the value. Press [▲] or [▼] to change the value. Move the cursor between the digits of the value by pressing [◀] or [▶].

Settings

- 0.01 to 9.99

- Press the [Confirmation] key to confirm every time the setting of an item is changed.

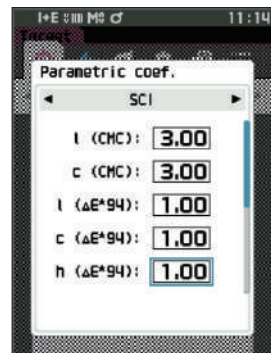

- 4 After all settings have been configured, use [▲] or [▼] to move the cursor to “OK”, and then press the [Confirmation] key.

The setting is confirmed and the screen returns to the <Pass/Fail> screen.

Memo If SCI+SCE is set for “Specular Component” under <Measurement setup>, use [◀] or [▶] to switch between SCI and SCE.

Notes If [ESC] is pressed during configuration, the settings will not be changed and the screen will return to the <Pass/Fail> screen.

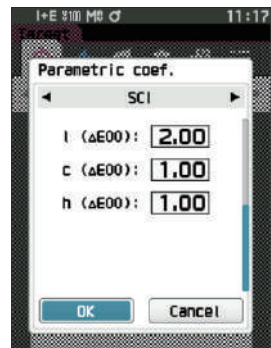

- 5 Press [ESC] to return to the <Pass/Fail> screen.

Input Colorimetric Data

Set the target by numerical input.

Select or specify the following items as the Input Colorimetric data.

- Color space: XYZ / L*a*b* / Hunter Lab
- Input Data: Enter the numeric value of the color space set above

Operating Procedure

Start the procedure from the <Target menu> screen.

- 1 Use [▲] or [▼] to move the cursor to “Input Colorimetric data”, and then press the [Confirmation] key to display the <Input Colorimetric data> screen.

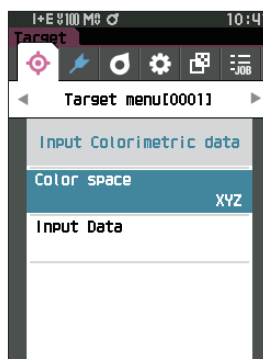

Color space

Specify which color space to input the colorimetric data.

Operating Procedure

Start the procedure from the <Target menu> - <Input Colorimetric data> screen.

- 1 Use [▲] or [▼] to move the cursor to “Color space”, and then press the [Confirmation] key. The <Color space> screen is displayed.

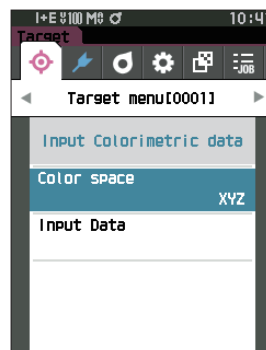

2 Use [▲] or [▼] to move the cursor to the item to set.

Settings

- XYZ : XYZ color space
- L*a*b* : L*a*b* color space
- Hunter Lab : Hunter Lab color space

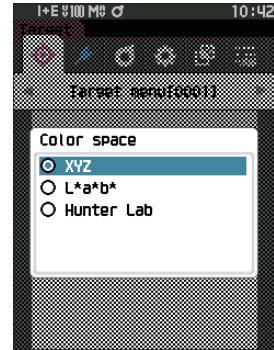

3 Press the [Confirmation] key.

The setting is confirmed and the screen returns to the <Input Colorimetric data> screen.

Notes If [ESC] is pressed during configuration, the settings will not be changed and the screen will return to the <Input Colorimetric data> screen.

Input Data

Create the color values for the color space selected in "Input Colorimetric data"- "Color space".

Operating Procedure

Start the procedure from the <Target menu> - <Input Colorimetric data> screen.

1 Use [▲] or [▼] to move the cursor to "Input Data", and then press the [Confirmation] key.

The Input data list screen is displayed.

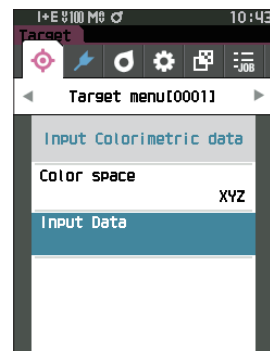

- 2 Use [▲] or [▼] to move the cursor to the item to set, and then press the [Confirmation] key. The <Input data> screen is displayed.

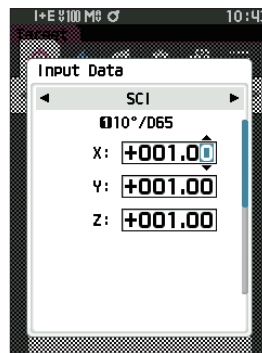

- 3 Use [▲] or [▼] to move the cursor to the item to set, and press the [Confirmation] key to change the setting.

- Press [◀] or [▶] to move the cursor to the setting value area. Pressing the [Confirmation] key causes the cursor to appear on the value. Press [▲] or [▼] to change the value. Move the cursor between the digits of the value by pressing [◀] or [▶].

Settings

- X·Y·Z : 0.01 ~ +300.000
- L* : 0.00 ~ +300.000
 - a*·b* : -300.00 ~ +300.00
- L : 0.00 ~ +300.000
 - a·b : -300.00 ~ +300.00
- Press the [Confirmation] key to confirm every time the setting of an item is changed.

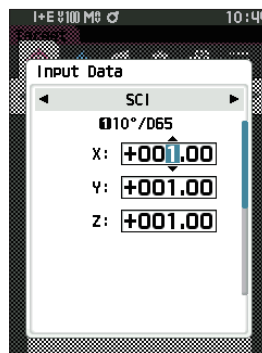

- 4 After all settings have been configured, use [▲] or [▼] to move the cursor to "OK", and then press the [Confirmation] key.

The setting is confirmed and the screen returns to the <Input Colorimetric data> screen.

Memo If SCI+SCE is set for "Specular Component" under <Measurement setup>, use [◀] or [▶] to switch between SCI and SCE.

Notes If you press the [ESC] key during setting, the setting value of the open screen is return to the value before the change.

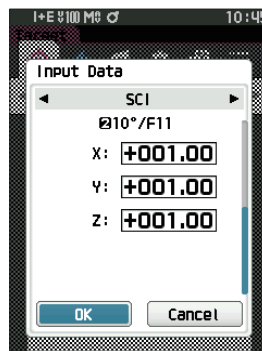

- 5 Press [ESC] to return to the <Input Colorimetric data> screen.

- Notes**
- If the selected target data number is already linked to the opacity-measured sample data, it cannot be registered. Delete the linked opacity data or change the selected target data number.
 - If you change Observer / Illuminant after entering input data Please note that the target data value is written as "----".

■ Default Data Settings

This instrument allows pass/fail judgment criteria to be set for individual color difference target data. Until such judgment criteria are set, the instrument is set with the default tolerance. Users can edit the tolerance that will be used as the judgment criteria as well as edit the warning level and the parametric coefficient default value.

Memo

- When a new target is measured, the default settings are initially applied.
- The default judgment criteria is set before judgment criteria for each target is set.
- Changing the default judgment criteria after the judgment criteria has already been set for individual targets, the judgment criteria specified for these targets will not be changed.
- The optional Color Data Software “SpectraMagic NX2” allows for easy configuration and use of judgment criteria.

Operating Procedure

Start the procedure from the measurement screen.

- 1 Press [MENU], and then use [◀] or [▶] to display the <Setting> screen.
- 2 Use [▲] or [▼] to move the cursor to “Default data setup”, and then press the [Confirmation] key to display the <Default data setup> screen.

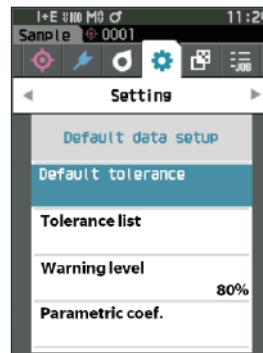
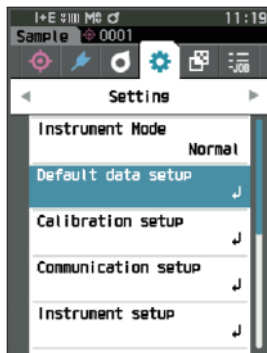

□ Tolerance List

Select the default index used for sample pass/fail judgment.

Operating Procedure

Start the procedure from the <Setting> - <Default data setup> screen.

- 1 Use [▲] or [▼] to move the cursor to “Tolerance list”, and then press the [Confirmation] key.

The available tolerances are displayed.

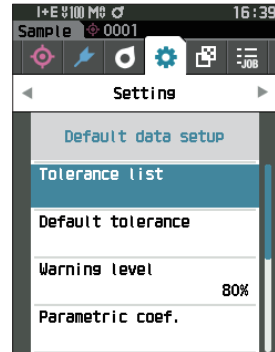

- 2 Use [▲] or [▼] to move the cursor to the item to set, and then press the [Confirmation] key.

- When the selected item is not currently checked, pressing the [Confirmation] key causes the item to be checked. When the selected item is currently checked, pressing the [Confirmation] key causes the item to be unchecked.
- Up to 14 indexes can be selected.

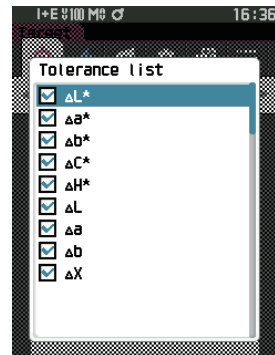

- 3 After all settings have been configured, use [▲] or [▼] to move the cursor to “OK”, and then press the [Confirmation] key.

The setting is confirmed and the screen returns to the <Default data setup> screen.

Pressing the [ESC] while configuring the settings will prevent the settings on the currently opened screen from being applied and revert all settings to the previous condition.

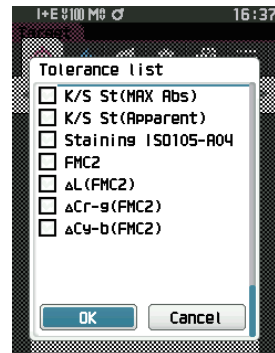

- 4 Press [ESC] to return to the <Default data setup> screen.

□ Default Tolerance Setting

Memo

- The default tolerance is set to the following values when the instrument is shipped from the factory.
 Lower limit: -1.00 / Upper limit: 1.00
 $\Delta x, \Delta y$ Lower limit: -0.0100 / Upper limit: 0.0100

Operating Procedure Start the procedure from the <Setting> - <Default data setup> screen.

1 Move the cursor to “Default tolerance”, and then press the [Confirmation] key.

The tolerance list screen is displayed.

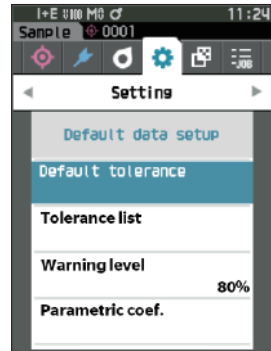

2 Use [▲] or [▼] to move the cursor to the item to set, and then press the [Confirmation] key.

The <Edit tolerance> screen is displayed.

3 Use [▲]/[▼] and [◀]/[▶] to move the cursor to the item to set, and then press the [Confirmation] key to change the setting.

- When the selected item is not currently checked, pressing the [Confirmation] key causes the item to be checked, after which the setting value can be changed.
- Press [◀] or [▶] to move the cursor to the setting value area. Pressing the [Confirmation] key causes the cursor to appear on the value. Press [▲] or [▼] to change the value. Move the cursor between the digits of the value by pressing [◀] or [▶].

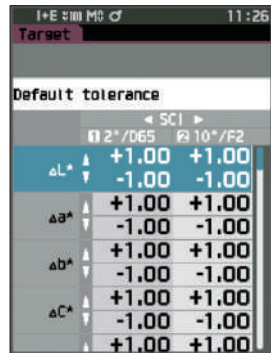

Settings

- x / y : -0.2000 to 0.2000
- Equation / MI : 0.00 to 20.00
- Other than the above :-20.00 to 20.00, etc.
- Press the [Confirmation] key to confirm every time the setting of an item is changed.

4 After all settings have been configured, use [▲] or [▼] to move the cursor to “OK”, and then press the [Confirmation] key.

The setting is confirmed and the screen returns to the <Edit tolerance> screen.

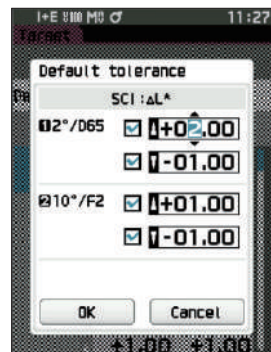

Memo

If SCI+SCE is set for “Specular Component” under <Measurement setup>, use [◀] or [▶] to switch between SCI and SCE.

5 Press [ESC] to return to the <Default data setup> screen.

Warning Level Setting

Memo The warning level is set to “80%” when the instrument is shipped from the factory.

Operating Procedure

Start the procedure from the <Setting> - <Default data setup> screen.

- 1 Use [▲] or [▼] to move the cursor to “Warning level”, and then press the [Confirmation] key. The <Warning level> screen is displayed.

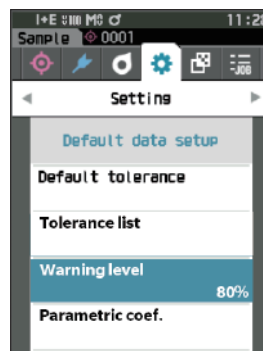

- 2 Use [▲] or [▼] to change the value.

Settings

○ 000 to 100%

- 3 Press the [Confirmation] key after completing the changes.

The setting is confirmed and the screen returns to the <Default data setup> screen.

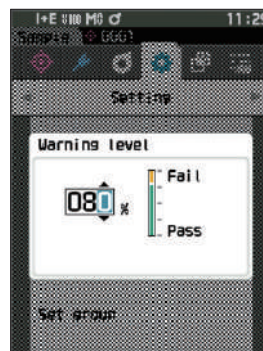

Notes If [ESC] is pressed during configuration, the settings will not be changed and the screen will return to the <Default data setup> screen.

□ Parametric Coefficient Setting

Memo The parametric coefficient is set to "1.00" when the instrument is shipped from the factory.

Operating Procedure

Start the procedure from the <Setting> - <Default data setup> screen.

- 1 Use [▲] or [▼] to move the cursor to "Parametric coef.," and then press the [Confirmation] key. The <Parametric coef.> screen is displayed.

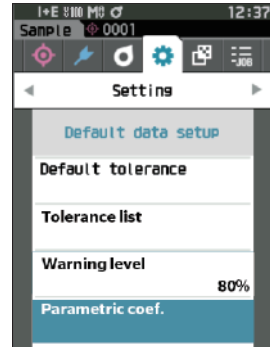

- 2 Use [▲] or [▼] to move the cursor to the item to be set, and then press the [Confirmation] key. The <Parametric coef.> edit screen is displayed.

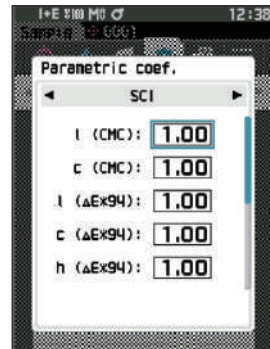

- 3 Use [▲] or [▼] to move the cursor to the item to set, and press the [Confirmation] key to change the setting.
 - Pressing the [Confirmation] key causes the cursor to appear on the value. Press [▲] or [▼] to change the value. Move the cursor between the digits of the value by pressing [◀] or [▶].

Settings

○ 0.01 to 9.99

- Press the [Confirmation] key to confirm every time the setting of an item is changed.

- 4 After all settings have been configured, use [▲] or [▼] to move the cursor to "OK", and then press the [Confirmation] key.

The setting is confirmed and the screen returns to the <Parametric coef.> screen.

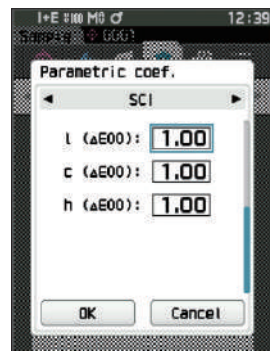

Memo If SCI+SCE is set for "Specular Component" under <Measurement setup>, use [◀] or [▶] to switch between SCI and SCE.

Notes If [ESC] is pressed during setup, the settings will not be changed and the screen will return to the <Parametric coef.> screen.

- 5 Press [ESC] to return to the <Default data setup> screen.

□ Set group

Create groups for registering targets in advance.

Memo No group name is set when the instrument is shipped from the factory.

Operating Procedure

Start the procedure from the <Setting> - <Default data setup> screen.

- 1 Use [▲] or [▼] to move the cursor to “Set group”, and then press the [Confirmation] key.

The <Edit group> screen is displayed.

The currently selected group numbers and names will be displayed in the upper table. The group is set by default when the target is measured.

The cursor will appear in the lower area with group numbers.

Configure the group name.

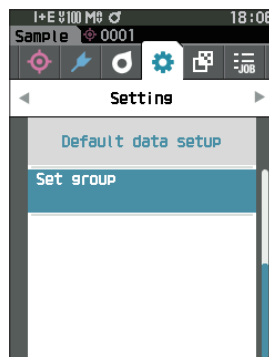

- 2 Use [▲] or [▼] to move the cursor to the group number of the group to edit. Numbers with blank names have not yet been set as a group. Assigning a name will register the number as a group. Users can also edit the names of existing groups.

Groups 01 through 50 can be set with up to 5 groups being available for registration.

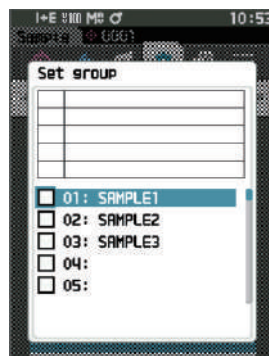

- 3 Check the box of the number to register to edit the name.

The <Edit name> screen is displayed.

Memo Checking the box registers the number to the table above, and when the target is measured, the number is automatically assigned to the affiliated group. To delete the information from the table, uncheck the box.



- 4 Use [▲]/[▼] or [◀]/[▶] to move the cursor between characters, and then press the [Confirmation] key.

- Up to 30 characters can be used.
- The selected character is displayed in the text box.

5 Repeat step 2 until the necessary characters have been entered.

- To delete the character to the left of the cursor in the text box, move the cursor to [x] and press the [Confirmation] key.

6 After inputting the characters, move the cursor to [OK] and press the [Confirmation] key.

The setting is confirmed and the screen returns to the <Set group> screen.

Memo If [ESC] is pressed during configuration, or if the cursor is moved to "Cancel" and the [Confirmation] key is pressed, the settings will not be changed and the screen will return to the <Set group> screen.

7 Move the cursor to [OK] (located below 50, which is at the very bottom), and press the [Confirmation] key.

The screen will return to the <Default data setup> screen.

Be aware that failure to press the [Confirmation] key on [OK] will cancel all data. Proceed with caution.

Chapter 3

Setting

Measurement Condition Settings.....	87
Measurement Condition Settings.....	87
Opacity Measurement	89
Measurement Option Settings	91
Observation Condition Settings	99
Display Settings.....	103
Instrument Settings.....	108
Measurement Instrument Option Settings	108

Measurement Condition Settings

This instrument requires measurement condition settings (measurement mode, average count, observer/illuminant, and display) to be configured before measurement can be started.

■ Measurement Condition Settings

To set measurement conditions, select the setting from the <Measurement cond.> menu. The following four items can be specified as the measurement conditions:

- Measurement mode : Select the combination of colorimetry and gloss measurement.
- Measurement setup : Specify the number of measurements for automatic and manual averaging.
- Observer/Illuminant : Configure the two observers/illuminants.
- Display cond. : Configure the display type, color space, color difference equation, and 14 custom display items.

Operating Procedure

- 1 Press [MENU], and then use [◀] or [▶] to display the <Measurement cond.> menu screen.

Memo To return to the **previous screen**, press [MENU] or [ESC].

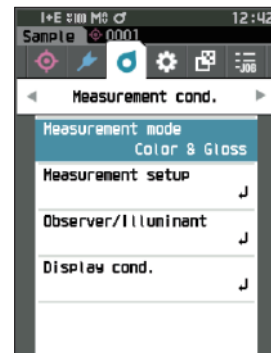

□ Measurement mode

Select a measurement mode.

Memo The measurement mode is set to “Color & Gloss” when shipped from the factory.

Operating Procedure

Start the procedure from the <Measurement cond.> screen.

- 1 Use [▲] or [▼] to move the cursor to “Measurement mode”, and then press the [Confirmation] key. The <Measurement mode> screen is displayed.



- 2 Use [▲] or [▼] to move the cursor to the desired measurement mode.

Settings

- Color & Gloss: Colorimetry + Gloss measurement (* CM-26dG only)
- Color only: Colorimetry
- Gloss only: Gloss measurement (* CM-26dG only)
- Opacity: Opacity value measurement

- 3 Press the [Confirmation] key to confirm, and then press [ESC].

The selection is confirmed and the screen returns to the previous screen.

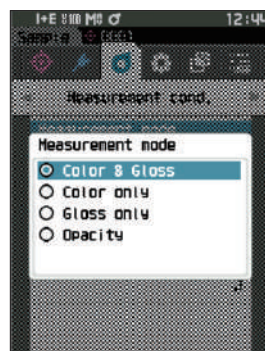

Notes If [ESC] is pressed without pressing the [Confirmation] key, the settings will not be changed and the screen will return to the previous screen.

■ Opacity Measurement

The transparency and opacity of paper are displayed as numerical values.

If the specimen is opaque, the value is determined only by the brightness of the specimen with no influence from the background, so the value for a white background will be the same as for a black background, and the opacity value (OP value) will be 100%.

Memo Manual averaging and SMC measurement cannot be used in Opacity mode, and the measurement conditions are only SCI or SCE. SCI+SCE cannot be selected.

Notes To measure in Opacity mode, the target must also be measured in Opacity mode. In addition, when measuring according to a specific international standard, the visual field and the light source must also be set according to the standard.

Preparation

1 Select "Opacity" under <Measurement cond.> - <Measurement mode>.

2 Press [ESC] on the menu screen to display the <Target> screen.

From the sample screen, press [] key to display the <Target> screen.

Operating Procedure

1 **Selecting or measuring a target**

Select a target measured beforehand in Opacity mode, or measure a new target in Opacity mode. Press the cancel button during the operation to return to the screen before measurement.

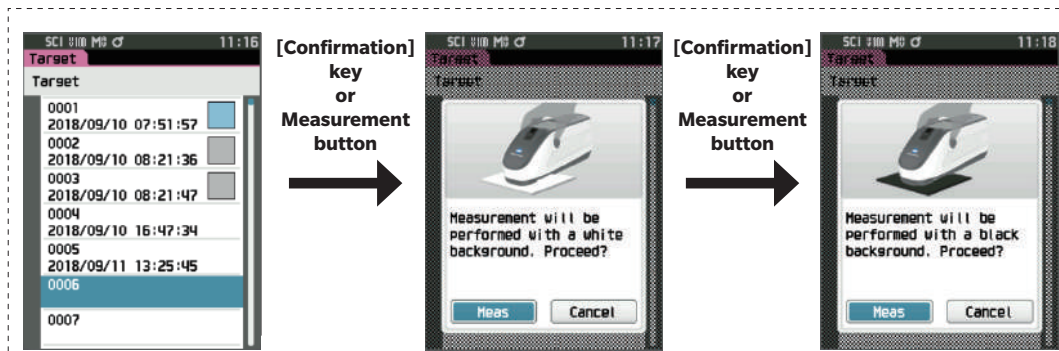

2 **Measuring a sample**

Press the cancel button during the operation to return to the screen before measurement.

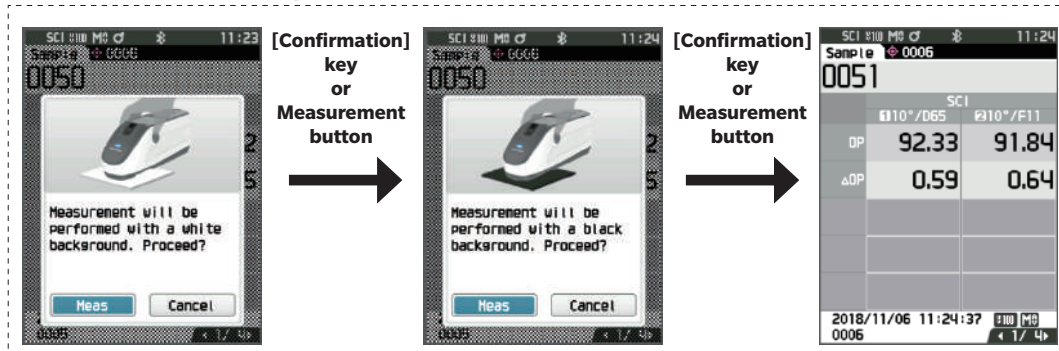

3 Displaying the results

Opacity value (OP value)
Color difference value

Sample: 0008

	#12°/D65	#10°/F2
OP	91.84	91.63
Δ OP	-0.60	-0.61

2018/09/10 16:49:05 11/14/18 0004

White background
L*a*b value

Sample: 0008

	White	Black
L*	91.39	91.60
a*	-9.21	-4.49
b*	37.52	41.86

2018/09/10 16:49:05 11/14/18 0004

Black background
L*a*b value

Sample: 0008

	Black	Black
L*	88.38	88.51
a*	-9.83	-5.07
b*	32.80	36.84

2018/09/10 16:49:05 11/14/18 0004

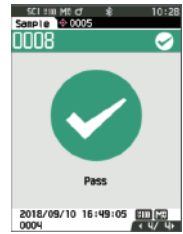

■ Measurement Option Settings

To set measurement options, select “Measurement setup” from the <Measurement cond.> menu screen. Select or specify the following items as the measurement options.

- Specular Component : SCI (incl. reflected light) / SCE (excl. reflected light) / Simultaneous SCI+SCE measurement
- UV (100%/0%/100% + 0%/UVC) : 100%: Measurement with a light source containing 100% UV components / 0%: Measurement with a light source containing no UV components / 100% + 0%: Simultaneous 100% + 0% measurement / UVC: UV control
- Auto average (1 to 10) : Specify the number of measurements for auto averaging.
- Manual average (1 to 30) : Specify the number of measurements for manual averaging.
- Manual average option : Select the save method when performing manual averaging.
- SMC average option : Select the save method when performing SMC average measurement. (When SMC function is ON)
- SMC : Remove outliers beyond the threshold before performing measurement.
- SMC Threshold : Set the threshold for SMC measurement.
- SMC Times (3 to 10) : Set the number of measurements to perform when performing SMC measurement.

Operating Procedure

Start the procedure from the measurement screen.

- 1 Press [MENU], and then use [◀] or [▶] to display the <Measurement cond.> menu screen.

Memo To return to the **previous screen**, press [MENU] or [ESC].



- 2 Use [▲] or [▼] to move the cursor to “Measurement setup”, and then press the [Confirmation] key. The <Measurement setup> screen is displayed.

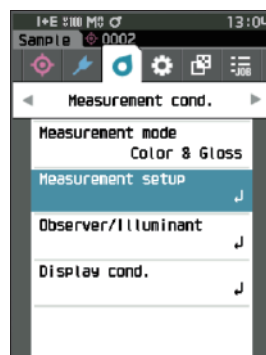

- 3 After setting the measurement conditions, press the [ESC] to return to the previous screen.

□ Specular Component

Select the method for processing the sample specular reflection light.

Memo The specular component is set to “SCI + SCE” when the instrument is shipped from the factory.

Operating Procedure

Start the procedure from the <Measurement cond.> - <Measurement setup> screen.

- 1 Use [▲] or [▼] to move the cursor to “Specular Component”, and then press the [Confirmation] key.



- 2 Use [▲] or [▼] to move the cursor to the item to set, and then press the [Confirmation] key.

Settings

- SCI : Measurement using a light source that contains specular reflection light.
- SCE : Measurement using a light source that does not contain specular reflection light.
- SCI+SCE : Displays the results of both SCI and SCE measurements.



- 3 Press the [Confirmation] key.

The selection is confirmed and the screen returns to the <Measurement setup> screen.

Notes If [ESC] is pressed without pressing the [Confirmation] key, the settings will not be changed and the screen will return to the <Measurement setup> screen.

□ UV (100%/0%/100% + 0%/UVC)

This instrument is equipped with a UV 0% option as a UV-free light source (with all UV rays up to 390 nm eliminated). Select the UV level according to the type of fluorescent agent being measured and the measuring method specified by the standard being followed.

Memo UV is set to "UV100%" when the instrument is shipped from the factory.

Operating Procedure

Start the procedure from the <Measurement cond.> - <Measurement setup> screen.

- 1 Use [▲] or [▼] to move the cursor to "UV", and then press the [Confirmation] key.



- 2 Use [▲] or [▼] to move the cursor to the item to set, and then press the [Confirmation] key.

Settings

- UV100% : Measurement with a light source containing 100% UV components
- UV0% : Measurement with a light source containing no UV components
- UV100% + 0% : Simultaneous UV 100% + UV 0% measurement
- UVC : UV control available

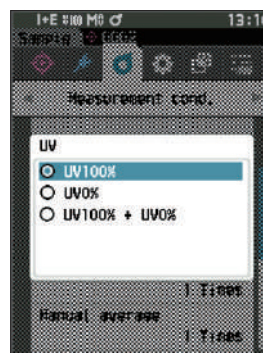

- Memo**
- UVC (UV control) is available only on firmware version 1.10 or later.
 - The UV control setting is configured using the optional Color Data Software SpectraMagic NX2. The setting is displayed and available only when output UV coefficients have been downloaded.
 - UV100% + 0% can only be used when the specular component is set to SCI or SCE.

- 3 Press the [Confirmation] key.

The selection is confirmed and the screen returns to the <Measurement setup> screen.

Notes If [ESC] is pressed without pressing the [Confirmation] key, the settings will not be changed and the screen will return to the <Measurement setup> screen.

□ Auto average (1 to 10)

Specify the number of measurements for auto averaging. Every time the measurement button is pressed, the average of the data obtained from the specified number of continuous measurements is determined as sample data.

Memo "1" is set as the number of measurements for automatic averaging when the instrument is shipped from the factory.

Operating Procedure

Start the procedure from the <Measurement cond.> - <Measurement setup> screen.

- 1 Use [▲] or [▼] to move the cursor to "Auto average", and then press the [Confirmation] key.



- 2 ▲ and ▼ will be displayed above and below the count in the count selection. Use [▲] or [▼] to specify a value.

Settings

- 1 to 10 times:
Specify the number of measurements, from 1 to 10, to perform when using auto averaging.

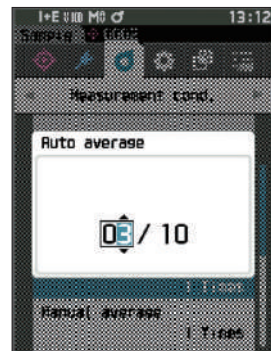

- 3 Press the [Confirmation] key.

The selection is confirmed and the screen returns to the <Measurement setup> screen.

Notes If [ESC] is pressed without pressing the [Confirmation] key, the settings will not be changed and the screen will return to the <Measurement setup> screen.

□ Manual average (1 to 30)

Specify the number of measurements for manual averaging. The average of the data obtained from the measurements conducted by pressing the measurement button the specified number of times is determined as sample data.

Memo "1" is set as the number of measurements for manual averaging when the instrument is shipped from the factory.

Operating Procedure

Start the procedure from the <Measurement cond.> - <Measurement setup> screen.

- 1 Use [▲] or [▼] to move the cursor to "Manual average", and then press the [Confirmation] key.



- 2 ▲ and ▼ will be displayed above and below the count in the count selection. Use [▲] or [▼] to specify a value.

Settings

- 1 to 30 times:

Specify the number of measurements, from 1 to 30, to perform when using manual averaging.



- 3 Press the [Confirmation] key.

The selection is confirmed and the screen returns to the <Measurement setup> screen.

Notes If [ESC] is pressed without pressing the [Confirmation] key, the settings will not be changed and the screen will return to the <Measurement setup> screen.

With manual average measurement, measurement is performed for the configured number of times the measurement button is pressed, and the average value of those measurements is saved as a single measurement. Selecting "Undo" after a measurement allows users to perform the previous measurement again.

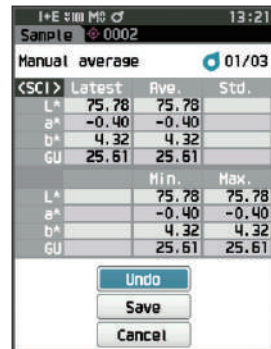

After the set number of measurements has been performed, the average can be saved by selecting "Save". To save the average automatically after the set number of measurements has been performed, select "Auto save" under "Measurement cond." - "Measurement setup" - "Manual average option".



□ SMC Function (Outlier-Free Measurement)

The SMC (Statistical Measurement Control) function acquires the average using values that minimize variations in the measured data.

Memo SMC is set to “OFF” when the instrument is shipped from the factory.

Operating Procedure

Start the procedure from the <Measurement cond.> - <Measurement setup> screen.

- 1 Use [▲] or [▼] to move the cursor to “SMC”, and then press the [Confirmation] key.

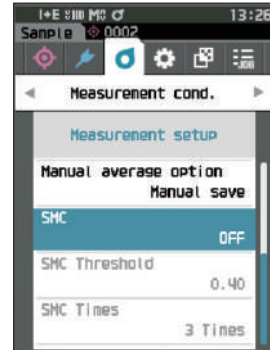

- 2 Use [▲] or [▼] to move the cursor to the item to set, and then press the [Confirmation] key.

Settings

- OFF
- ON

Notes Setting the SMC function to ON will disable manual averaging.



- 3 Press the [Confirmation] key.

The selection is confirmed and the screen returns to the <Measurement setup> screen.

Notes If [ESC] is pressed without pressing the [Confirmation] key, the settings will not be changed and the screen will return to the <Measurement setup> screen.

□ SMC Threshold

Sets the threshold to be used for the sample SMC function.

Memo

- The SMC threshold is set to "0.4" when the instrument is shipped from the factory.
- For the threshold value, enter a value equivalent to the desired $\sigma\Delta E^*ab$ for the average measurement data group (average data entries set on P.98).

Operating Procedure

Start the procedure from the <Measurement cond.> - <Measurement setup> screen.

- 1 Use [▲] or [▼] to move the cursor to "SMC Threshold", and then press the [Confirmation] key.

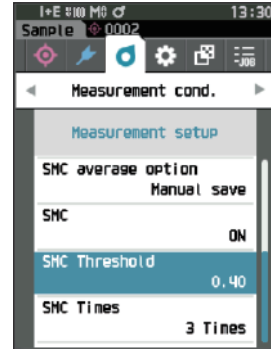

- 2 ▲ and ▼ are displayed above and below the number to be set.
Use [▲] or [▼] to specify a value.

Settings

○ 0.01 to 9.99



- 3 Press the [Confirmation] key.
The selection is confirmed and the screen returns to the <Measurement setup> screen.

Notes

If [ESC] is pressed without pressing the [Confirmation] key, the settings will not be changed and the screen will return to the <Measurement setup> screen.

□ SMC Times

Sets the threshold to be used for the sample SMC function.

Sets the number of measurements to perform when performing SMC average measurement. The average of the data obtained from the measurements conducted by pressing the measurement button several times is determined. The maximum number of measurements at this time is specified number in the setting + four times.

Memo "3" is set as the number of measurements for SMC averaging when the instrument is shipped from the factory.

Operating Procedure

Start the procedure from the <Measurement cond.> - <Measurement setup> screen.

- 1 Use [▲] or [▼] to move the cursor to "SMC Times", and then press the [Confirmation] key.

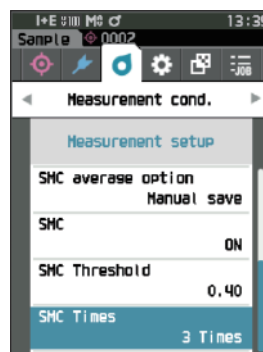

- 2 ▲ and ▼ will be displayed above and below the count in the count selection. Use [▲] or [▼] to specify a value.

Settings

- 3 to 10 times



- 3 Press the [Confirmation] key.

The selection is confirmed and the screen returns to the <Measurement setup> screen.

Notes If [ESC] is pressed without pressing the [Confirmation] key, the settings will not be changed and the screen will return to the <Measurement setup> screen.

With SMC average measurement, measurement is performed for the configured number of measurements, and the average value of those measurements is saved as a single measurement.

After the set number of measurements has been performed, the average can be saved by selecting "Save".

To save the average automatically after the set number of measurements has been performed, select "Auto save" under "Measurement cond." - "Measurement setup" - "SMC average option".

■ Observation Condition Settings

To set observation conditions, select “Observer/Illuminant” from the <Measurement cond.> menu screen. The following two observer/illuminant settings can be configured for the observation conditions.

- Observer/Illuminant 1: Select the observer/illuminant used to measure the colorimetric value.
- Observer/Illuminant 2: Select the secondary illuminant used for MI (metamerism index) calculation, etc.

Operating Procedure

Start the procedure from the measurement screen.

- 1 Press [MENU], and then use [◀] or [▶] to display the <Measurement cond.> menu screen.

Memo To return to the previous screen, press [MENU] or [ESC].



- 2 Use [▲] or [▼] to move the cursor to “Observer/Illuminant”, and then press the [Confirmation] key. The <Observer/Illuminant> screen is displayed.

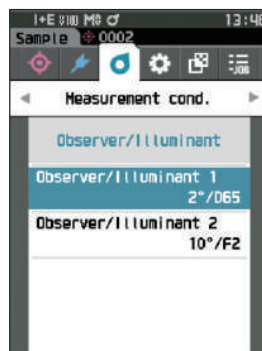

- 3 After setting the observer/illuminant, press [ESC] to return to the previous screen.

□ Observer/Illuminant 1

Select an observer angle of either 2° or 10° and the illuminant used to measure colorimetric value.

Memo Observer/Illuminant 1 is set to “10°/D65” when the instrument is shipped from the factory.

Operating Procedure

Start the procedure from the <Measurement cond.> - <Observer/Illuminant> screen.

1 Use [▲] or [▼] to move the cursor to “Observer/Illuminant 1”, and then press the [Confirmation] key.

The <Observer/Illuminant 1> screen is displayed.

The scroll bar on the right of the screen shows that there are additional observer/illuminant settings that cannot fit on the screen.

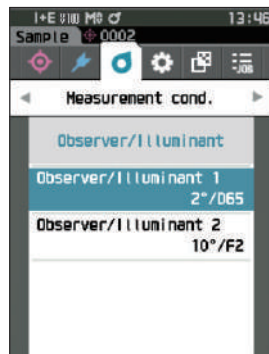

2 Use [▲] or [▼] to move the cursor to the desired item.

Moving the cursor past the top or bottom of the list will show additional observers/illuminants that cannot fit on the screen.

Settings

- 2°: 2° observer angle (CIE 1931)
- 10°: 10° observer angle (CIE 1964)
- and
- A : Standard illuminant A (Incandescent lamp, Color temperature: 2856K)
- C : Illuminant C (Daylight, Small relative value of spectral distribution in the ultraviolet region; Color temperature: 6774K)
- D65 : Standard illuminant D₆₅ (Daylight, Color temperature: 6504K)
- D50 : Standard illuminant D₅₀ (Daylight, Color temperature: 5003K)
- ID65 : Indoor daylight illuminant ID65 (Daylight after passing through window glass, Color temperature: 6504K)
- ID50 : Indoor daylight illuminant ID50 (Daylight after passing through window glass, Color temperature: 5003K)
- F2 : Cool white (fluorescent lamp)
- F6 : Cool white (fluorescent lamp)
- F7 : Color rendering A daylight natural (fluorescent lamp)
- F8 : Color rendering AAA natural white (fluorescent lamp)
- F10 : 3-band type natural white (fluorescent lamp)
- F11 : 3-band type cool white (fluorescent lamp)
- F12 : 3-band type warm white (fluorescent lamp)
- LED-B1 : Blue exciting phosphor type LED (Color temperature: 2733 K)
- LED-B2 : Blue exciting phosphor type LED (Color temperature: 2998 K)
- LED-B3 : Blue exciting phosphor type LED (Color temperature: 4103 K)
- LED-B4 : Blue exciting phosphor type LED (Color temperature: 5109 K)
- LED-B5 : Blue exciting phosphor type LED (Color temperature: 6598 K)
- LED-BH1 : Hybrid type LED consisting of mix of phosphor-replaced blue LED and red LED (Color temperature: 2851 K)
- LED-RGB1: LED mixing three LED (red, green, blue) (Color temperature: 2840 K)
- LED-V1 : Purple exciting phosphor type LED (Color temperature: 2724 K)

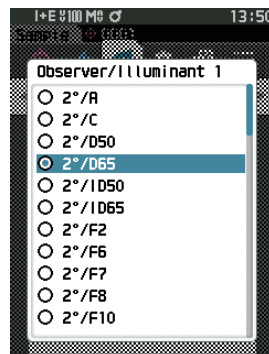

- LED-V2 : Purple exciting phosphor type LED (Color temperature: 4070 K)
(* When selecting an LED light source such as LED-B1, if the optional accessory Color Data Software SpectraMagic NX2 is in use, it must be version 1.5 or later, and if Spectrophotometer Configuration Tool CM-CT1 is in use, it must be version 1.51 or later.)
- User : User-configured illuminant
(* SpectraMagic NX2 is required for setting user-configured illuminants. Note that the name configured in SpectraMagic NX2 will be displayed.)

3 Press the [Confirmation] key.

The selection is confirmed and the screen returns to the **<Observer/Illuminant> screen.**

Notes If [ESC] is pressed without pressing the [Confirmation] key, the settings will not be changed and the screen will return to the <Observer/Illuminant> screen.

□ Observer/Illuminant 2

Select the secondary illuminant used for MI (metamerism index) calculation, etc.

Memo Observer/Illuminant 2 is set to "10°/F11" when the instrument is shipped from the factory.

Operating Procedure

Start the procedure from the <Measurement cond.> - <Observer/Illuminant> screen.

- 1 Use [▲] or [▼] to move the cursor to "Observer/Illuminant 2", and then press the [Confirmation] key. The <Observer/Illuminant 2> screen is displayed.

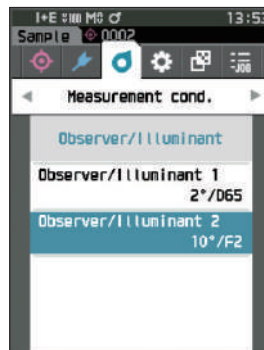

- 2 Use [▲] or [▼] to move the cursor to the desired item.

Settings

- The setting values are the same as those for "Observer/Illuminant 1" or "None".

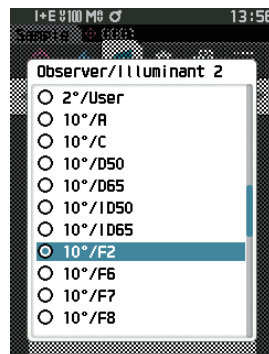

- 3 Press the [Confirmation] key.

The selection is confirmed and the screen returns to the <Observer/Illuminant> screen.

Notes If [ESC] is pressed without pressing the [Confirmation] key, the settings will not be changed and the screen will return to the <Observer/Illuminant> screen.

■ Display Settings

To set display settings, select “Display cond.” from the <Measurement cond.> menu screen. The following four items (three items and 14 custom display items) can be specified as the display conditions.

- Display type : Select the screen to be displayed.
- Color space : Select the color space to be displayed.
- Equation : Select the color for which the color difference will be measured.
- Custom (01 to 14) : Select which options to add to the display, such as display color value, index, and color difference.

Operating Procedure

Start the procedure from the measurement screen.

- 1 Press [MENU], and then use [◀] or [▶] to display the <Measurement cond.> menu screen.

Memo To return to the previous screen, press [MENU] or [ESC].

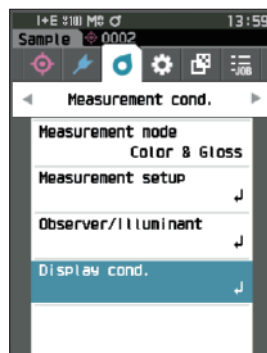

- 2 Use [▲] or [▼] to move the cursor to “Display cond.”, and then press the [Confirmation] key. The <Display cond.> screen is displayed.



- 3 After setting the display conditions, press [ESC] to return to the previous screen.

□ Display type

Configure the display type for the measurement results.

Memo All display types are selected when the instrument is shipped from the factory.

Operating Procedure

Start the procedure from the <Measurement cond.> - <Display cond.> screen.

- 1 Use [▲] or [▼] to move the cursor to “Display type”, and then press the [Confirmation] key.

The <Display type> screen is displayed.



- 2 Use [▲] or [▼] to move the cursor to the desired display type, and then press the [Confirmation] key.

Settings

- Absolute value: Displays the absolute values of the colorimetric and the gloss values.
- Difference: Displays the color difference and gloss value difference against the target. The measurement that failed the pass/fail judgment based on the tolerance will be highlighted in red.
- Abs. & Diff.: Displays the absolute value and the color difference and gloss value difference against the target. The measurement that failed the pass/fail judgment based on the tolerance will be highlighted in red.
- Pass/Fail: Determines whether the color difference and gloss value difference related to the target are within the tolerance range set in advance. If within the tolerance, the judgment will be displayed as “Pass”. If even one difference is not within the tolerance, the judgment will be displayed as “Fail”.
- Custom: Displays the display color value and index set under “Custom” as the two illuminants.
- Abs. Graph: Displays a graph of the absolute values of the colorimetric and the gloss values.
- Diff. Graph: Displays a graph showing the color difference and gloss value difference against the target.
- Spectral Graph: Displays a graph showing the spectral reflectance. The [Confirmation] key can be used to move the wavelength displaying the spectral reflectance value.

Memo A check mark means the item is selected.

- 3 After all settings have been configured, use [▲] or [▼] to move the cursor to “OK”, and then press the [Confirmation] key.

The selection is confirmed and the screen returns to the previous screen.

Notes If [ESC] is pressed without pressing the [Confirmation] key, the settings will not be changed, and the screen will return to the <Display cond.> screen.

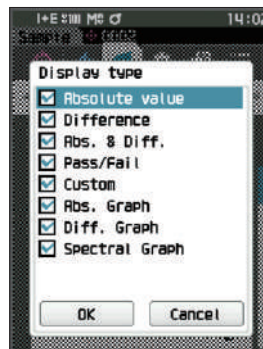

□ Color space

Select the color space to be used.

Memo The color space is set to "L*a*b*" when the instrument is shipped from the factory.

Operating Procedure

Start the procedure from the <Measurement cond.> - <Display cond.> screen.

- 1 Use [▲] or [▼] to move the cursor to "Color space", and then press the [Confirmation] key. The <Color space> selection screen is displayed.

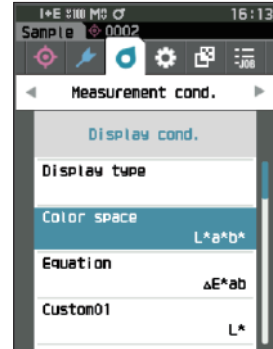

- 2 Use [▲] or [▼] to move the cursor to the desired color space.

Settings

- L*a*b*: L*a*b* color space
- L*C*h: L*C*h color space
- Hunter Lab: Hunter Lab color space
- Yxy: Yxy color space
- XYZ: XYZ color space
- Munsell (C): Munsell color space

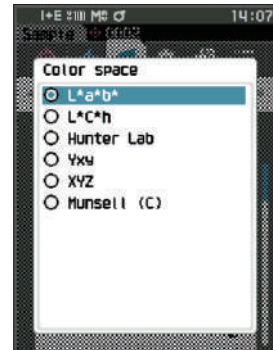

- 3 Press the [Confirmation] key to confirm, and then press [ESC].

The selection is confirmed and the screen returns to the previous screen.

Notes If [ESC] is pressed without pressing the [Confirmation] key, the settings will not be changed, and the screen will return to the <Display cond.> screen.

□ Color difference equation

Select the color difference equation to be used.

Memo The color difference equation is set to “ ΔE^*ab ” when the instrument is shipped from the factory.

Operating Procedure

Start the procedure from the <Measurement cond.> - <Display cond.> screen.

- 1 Use [\blacktriangle] or [\blacktriangledown] to move the cursor to “Equation”, and then press the [Confirmation] key. The <Equation> screen is displayed.



- 2 Use [\blacktriangle] or [\blacktriangledown] to move the cursor to the desired color difference equation.

Settings

- ΔE^*ab : ΔE^*ab (CIE 1976) color difference equation
- CMC: CMC color difference equation; Parameters can be changed.
- ΔE^*94 : ΔE^*94 (CIE 1994) color difference equation; Parameters can be changed.
- $\Delta E00$: $\Delta E00$ (CIE DE 2000) color difference equation; Parameters can be changed.
- ΔE (Hunter): Hunter Lab color difference equation
- $\Delta E99o$: $\Delta E99o$ (DIN99o) color difference equation
- FMC2: FMC-2 color difference equation

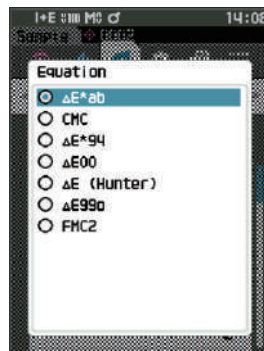

- 3 Press the [Confirmation] key to confirm, and then press [ESC].

The selection is confirmed and the screen returns to the previous screen.

Notes If [ESC] is pressed without pressing the [Confirmation] key, the settings will not be changed, and the screen will return to the <Display cond.> screen.

□ Custom

Select the items, including the color space, color difference equation, or index, to be used. Up to 14 items (Custom 01 to Custom 14) to be displayed can be set.

This selection screen is available when the user index has been set with the Spectrophotometer Configuration Tool CM-CT1 (Ver. 1.4 or later) in advance. In this case, the name configured in the CM-CT1 will be displayed.

Memo In addition to the CM-CT1 (Ver. 1.4 or later), an optional Color Data Software SpectraMagic NX2 license is required for setting user indexes.

Operating Procedure

Start the procedure from the <Measurement cond.> - <Display cond.> screen.

1 Use [▲] or [▼] to move the cursor to “Custom xx (01 to 14)”, and then press the [Confirmation] key.

The screen for selecting the display items is displayed.

The scroll bar at the right on the screen shows that there are additional display items that cannot fit on the screen.

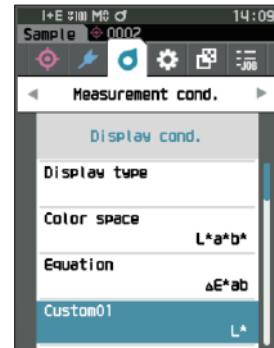

2 Use [▲] or [▼] to move the cursor to the desired display item.

Moving the cursor past the top or bottom of the list will show additional display items that cannot fit on the screen.

Settings

The following indexes as well as display color values and color differences for color spaces that can be configured under color space and color difference equation can be set.

- Wle (WI E313-73) and ΔWle : Whiteness index (ASTM E313-73)
- Wlc (WI CIE) and ΔWlc : Whiteness index (CIE 1982/ASTM E313-98 (D65 Light source))
- Tint (Tint CIE) and ΔTint : Tint (CIE 1982/ASTM E313-98 (D65 Light source))
- Yle (YI E313-73) and ΔYle : Yellowness index (ASTM E313-73)
- Yld (YI D1925) and ΔYld : Yellowness index (ASTM D1925)
- B (ISO B) and ΔB : Brightness
- DXYZ/DX/DY/DZ : Tristimulus Strength
- MI : Metamerism
- GU, ΔGU : CM-26dG : Gloss index
8°GU : CM-26d, 25d
- ΔE99o : ΔE99o (DIN99o) color difference equation
- Greyscale (ISO A105) : Grey Scale (ISO 105-A05)
- WI (Ganz) and ΔWI (Ganz) : Whiteness index (Ganz & Griesser)
- Tint (Ganz) and ΔTint (Ganz) : Tint (Ganz & Griesser)
- Staining ISO 105-A04 : Staining degree (ISO 105-A04)
- FMC2 : FMC-2 color difference equation
- ΔL(FMC2)
- ΔCr-g(FMC2)
- ΔCy-b(FMC2)

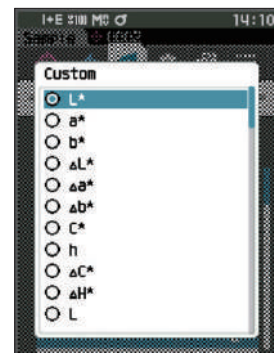

- K/S St (ΔE^*) : K/S concentration (differential comparison equation (ΔE^*ab))
- K/S St (MAX Abs) : K/S concentration (maximum absorption wavelength formula)
- K/S St (Apparent) : K/S concentration (full wavelength formula)
- None
- UE1 to UE3 : User index
- UC1 to UC3 : User class

3 Press the [Confirmation] key to confirm, and then press [ESC].

The selection is confirmed and the screen returns to the previous screen.

Notes If [ESC] is pressed without pressing the [Confirmation] key, the settings will not be changed, and the screen will return to the <Display cond.> screen.

Instrument Settings

■ Measurement Instrument Option Settings

To set measurement instrument options, select “Instrument setup” from the <Setting> screen.

Operating Procedure Start the procedure from the measurement screen.

1 Press [MENU], and then use [◀] or [▶] to display the <Setting> screen.

Memo To return to the previous screen, press [MENU] or [ESC].

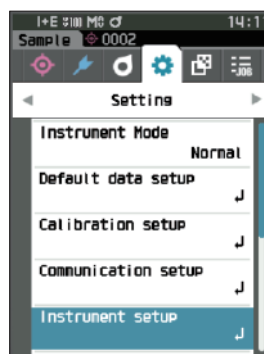

2 Use [▲] or [▼] to move the cursor to “Instrument setup”, and then press the [Confirmation] key. The <Instrument setup> screen is displayed.

3 After setting the measurement instrument conditions, press [ESC] to return to the previous screen.



□ User type

Settings can be protected for each user.

Memo The user type is set to “Administrator” when the instrument is shipped from the factory.

Operating Procedure

Start the procedure from the <Setting> - <Instrument setup> screen.

- 1 Use [▲] or [▼] to move the cursor to “User type”, and then press the [Confirmation] key. The <User type> setting screen is displayed.



- 2 Use [▲] or [▼] to move the cursor and select the user type.

Settings

- Administrator: All settings can be changed.
- Worker: Some settings cannot be changed.

Memo The operations that workers can perform are as follows.

- “Sample” browsing/measurement/printing/deletion
- “Target” browsing/printing
- Calibration
- Instrument info. displaying
- Changing the user type



Notes Settings for operations that workers can perform can be changed using the Spectrophotometer Configuration Tool CM-CT1.

Memo It is possible to set a password for changing workers to administrators. For details, read P.117 “Password Setting”.

- 3 Press the [Confirmation] key to confirm, and then press [ESC].

The selection is confirmed and the screen returns to the <Instrument setup> screen.

Notes If [ESC] is pressed without pressing the [Confirmation] key, the settings will not be changed, and the screen will return to the <Instrument setup> screen.

□ Display Language Settings

This instrument allows the display language to be set.

Pressing and holding [MENU] while starting up the instrument also displays the language setting screen.

Memo The language is set to “English” when the instrument is shipped from the factory.

Notes When the backup battery of the instrument has gone dead, the display language is reset to “English”.

Operating Procedure

Start the procedure from the <Setting> - <Instrument setup> screen.

- 1 Use [▲] or [▼] to move the cursor to “Language”, and then press the [Confirmation] key.

The <Language> screen is displayed.

The scroll bar at the right on the <Language> screen shows that there are additional language settings that cannot fit on the screen.



- 2 Use [▲] or [▼] to move the cursor to the desired language.

Moving the cursor past the top or bottom of the list will show additional language settings that cannot fit on the screen.

Settings

- English
- Japanese
- German
- French
- Spanish
- Italian
- Chinese
- Portuguese
- Polish
- Russian
- Turkish

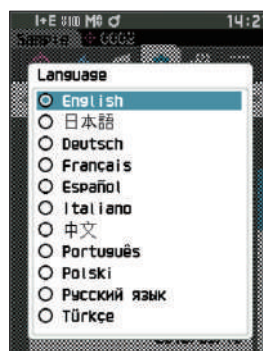

- 3 Press the [Confirmation] key to confirm, and then press [ESC].

The selection is confirmed and the screen returns to the <Instrument setup> screen.

Notes If [ESC] is pressed without pressing the [Confirmation] key, the settings will not be changed, and the screen will return to the <Instrument setup> screen.

□ Date Format Settings

The format of the date displayed on the screen can be changed.

Memo The date format is set to “yyyy/mm/dd” when the instrument is shipped from the factory.

Operating Procedure

Start the procedure from the <Setting> - <Instrument setup> screen.

- 1 Use [▲] or [▼] to move the cursor to “Date format”, and then press the [Confirmation] key.

The <Date format> screen is displayed.



- 2 Use [▲] or [▼] to move the cursor to the desired measurement mode.

Settings

- yyyy/mm/dd : The date is displayed in year/month/day order.
- mm/dd/yyyy : Display the date in the format of month/day/year.
- dd/mm/yyyy : Display the date in the format of day/month/year.

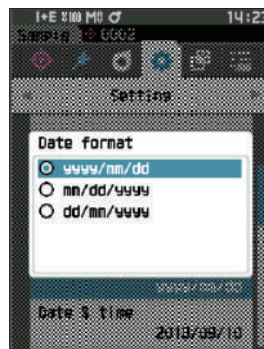

- 3 Press the [Confirmation] key to confirm, and then press [ESC].

The selection is confirmed and the screen returns to the <Instrument setup> screen.

Notes If [ESC] is pressed without pressing the [Confirmation] key, the settings will not be changed, and the screen will return to the <Instrument setup> screen.

□ Clock Settings

This instrument has a built-in clock to record the date and time of measurement. Because the date and time have been set at the factory, there is no need to change these settings under normal conditions. If necessary, however, the date and time settings may be configured.

Operating Procedure

Start the procedure from the <Setting> - <Instrument setup> screen.

- 1 Use [▲] or [▼] to move the cursor to “Date & time”, and then press the [Confirmation] key.

The <Date & time> setting screen is displayed.

- 2 Use [▲] or [▼] to move the cursor to the item to be set, and then press the [Confirmation] key.

The cursor color turns to blue and ▲ and ▼ are displayed above and below the cursor.



- 3 Use [▲] or [▼] to change the value.

Settings

- Year : 2000 to 2099
- Month : 1 to 12
- Day : 1 to 28, 29, 30 and 31
- Hour : 0 to 23
- Minute : 0 to 59
- The value increases/decreases by one with each button press.
- Holding down [▲] or [▼] increases/decreases the value by one continuously.
- Use [◀] or [▶] to move between digits.



- 4 Press the [Confirmation] key.

The setting is confirmed.

Notes If [ESC] is pressed without pressing the [Confirmation] key, the settings will not be changed.

- 5 Repeat Steps 2 to 4 for each of the date (Year/ Month/Day) and time (Hour : Minute) parameters.

- 6 After all settings have been configured, use [▲] or [▼] to move the cursor to “OK”, and then press the [Confirmation] key.

The selection is confirmed and the screen returns to the <Instrument setup> screen.

Notes If [ESC] is pressed without pressing the [Confirmation] key, the settings will not be changed and the screen will return to the <Instrument setup> screen.

□ Screen Brightness

The brightness of the LCD can be set in five levels. Selecting a darker level is effective for power saving.

Memo Screen brightness is set to “3 (Standard)” when the instrument is shipped from the factory.

Operating Procedure

Start the procedure from the <Setting> - <Instrument setup> screen.

- 1 Use [▲] or [▼] to move the cursor to “Brightness”, and then press the [Confirmation] key. The <Brightness> setting screen is displayed.

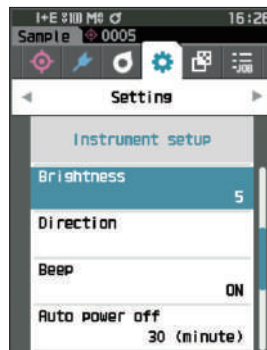

- 2 Use [▲] or [▼] to move the cursor to the desired brightness.

Settings

- 5 (Light)
- 4
- 3 (Standard)
- 2
- 1 (Dark)

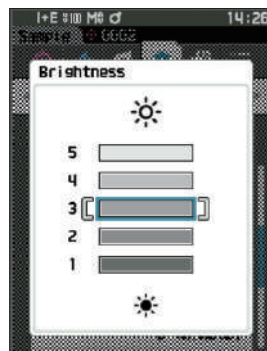

- 3 Press the [Confirmation] key to confirm, and then press [ESC].

The selection is confirmed and the screen returns to the <Instrument setup> screen.

Notes If [ESC] is pressed without pressing the [Confirmation] key, the settings will not be changed, and the screen will return to the <Instrument setup> screen.

□ LCD Screen Display Orientation

Depending on how the instrument is held, the display may be more visible upside-down. This function allows the display to be set to a different orientation in such instances.

Operating Procedure

Start the procedure from the <Setting> - <Instrument setup> screen.

- 1 Use [▲] or [▼] to move the cursor to “Direction”, and then press the [Confirmation] key.

The display will flip upside-down and return to the <Instrument setup> screen.

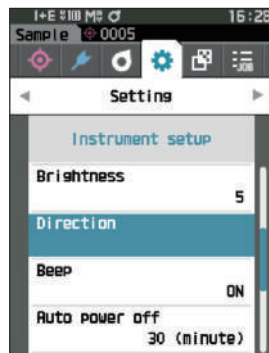

□ Beep

Operation sounds can be set to ON or OFF.

Memo The “Beep” setting is set to “ON” when the instrument is shipped from the factory.

Operating Procedure

Start the procedure from the <Setting> - <Instrument setup> screen.

- 1 Use [▲] or [▼] to move the cursor to “Beep”, and then press the [Confirmation] key. The <Beep> setting screen is displayed.

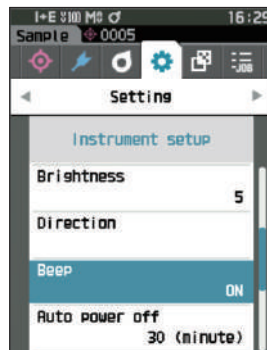

- 2 Use [▲] or [▼] to move the cursor to select ON or OFF.

Settings

- OFF
- ON (Standard)

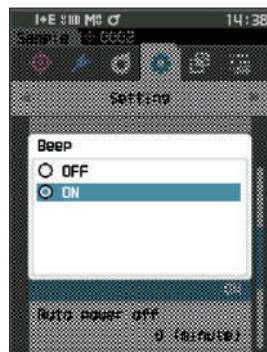

- 3 Press the [Confirmation] key to confirm, and then press [ESC].

The selection is confirmed and the screen returns to the <Instrument setup> screen.

Notes If [ESC] is pressed without pressing the [Confirmation] key, the settings will not be changed, and the screen will return to the <Instrument setup> screen.

□ Auto Power Off

The amount of time before switching the power off can be set.

Memo Auto power off is set to “30 (minutes)” when the instrument is shipped from the factory.

Operating Procedure

Start the procedure from the <Setting> - <Instrument setup> screen.

- 1 Use [▲] or [▼] to move the cursor to “Auto power off”, and then press the [Confirmation] key. The <Auto power off> setting screen is displayed.

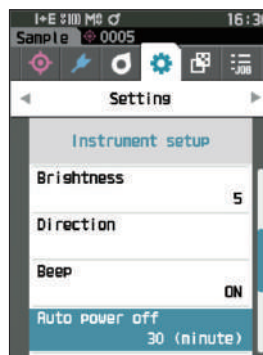

- 2 Use [▲] or [▼] to change the value.
Settings

○ 00 to 60 minutes

Memo Setting to “00” minutes will change the setting to “Do not power off”.

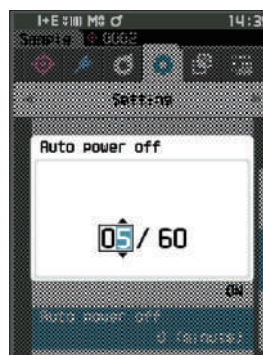

- 3 Press the [Confirmation] key to confirm, and then press [ESC].

The selection is confirmed and the screen returns to the <Instrument setup> screen.

Notes If [ESC] is pressed without pressing the [Confirmation] key, the settings will not be changed, and the screen will return to the <Instrument setup> screen.

□ Password Setting

The password required for changing the user type from a worker to an administrator can be configured in the instrument setup.

Operating Procedure

Start the procedure from the <Setting> - <Instrument setup> screen.

- 1 Use [▲] or [▼] to move the cursor to “Password Setting”, and then press the [Confirmation] key. The <Password Setting> screen is displayed.



- 2 Use [◀]/[▶] or [▲]/[▼] to set the password.
Settings
8 digits (Initial value "00000000": No set password)



- 3 Press the [Confirmation] key.
The selection is confirmed and the screen returns to the <Measurement setup> screen.

Notes If [ESC] is pressed without pressing the [Confirmation] key, the settings will not be changed and the screen will return to the <Measurement setup> screen.

□ Wake On Mode Settings

Wake On Mode allows the instrument to be turned ON/OFF via communication.

Memo Wake On Mode is set to “OFF” when the instrument is shipped from the factory.

Notes When connecting to the instrument via the wireless communication function and using Wake On Mode, use the AC adapter.

Operating Procedure

Start the procedure from the <Setting> - <Instrument setup> screen.

- 1 Use [▲] or [▼] to move the cursor to “Wake On Mode”, and then press the [Confirmation] key.
The <Wake On Mode> settings screen is displayed.

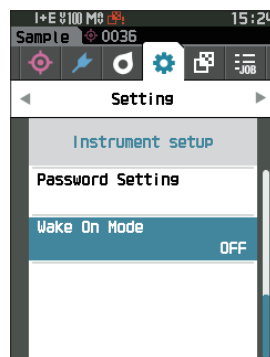

- 2 Use [▲] or [▼] to move the cursor to select ON or OFF.

Settings

- OFF (Standard)
- ON

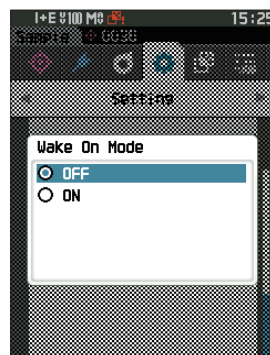

- 3 Press the [Confirmation] key.
The selection is confirmed and the screen returns to the <Instrument setup> screen.

Notes If [ESC] is pressed without pressing the [Confirmation] key, the settings will not be changed, and the screen will return to the <Instrument setup> screen.

MEMO

Chapter 4

Other Functions

Connecting to an External Device.....	121
Connecting to a Computer	121
Connecting via USB Cable	122
Connecting Via Wireless LAN/Bluetooth	123
Communication Setup (When Using Bluetooth) ...	124
Communication Setup (When Using Wireless LAN Function: Ad Hoc Method)	127
Communication Setup (When Using Wireless LAN Function: Infrastructure Method)	129
Connecting to a Printer/Barcode Reader	131
Instrument Preparation.....	132
System Settings	137
Calibration setup	137
Displaying Diagnosis Info.....	142
Displaying the Instrument Information	143
JOB Function.....	144

Connecting to an External Device

This instrument includes a USB connection terminal and a wireless communication function (when the optional WLAN / Bluetooth module is attached). The supplied USB cable (IF-A26) or WLAN/Bluetooth module CM-A300 can be used to connect the instrument to a computer to send data, or Bluetooth communication can be used to connect the instrument to a printer, allowing for printing.

Notes When the instrument is exposed to strong external static electricity or is affected by ambient interference during communication with an external device, the communication may be interrupted. In this case, turn the power OFF and then turn it ON again.

Connecting to a Computer

There are two methods for connecting the instrument to a computer: connecting using the USB cable or via the Instrument's wireless communication function.

Notes

- To use the instrument's wireless communication function to connect to a computer with WLAN or Bluetooth communication capabilities, the optional CM-A300 WLAN / Bluetooth module must be correctly connected to the instrument and a WLAN or Bluetooth communication channel must be opened through the computer's utilities function.
- A simultaneous connection via the USB cable and the wireless communication function is not possible.

Memo

- When connected to a computer, the wireless communication or the wired communication mark is displayed on the LCD screen (refer to P.23 "Status bar"), and the measurement button and operation keys on the instrument are disabled.
- If a command to enable the measuring button is sent from the computer, measurement will be possible by pressing the measurement button on the instrument. Note that, at this time, sample is transferred to the computer without being stored in the instrument memory.
- To connect the instrument to a computer, use of software that enables connection and operation of the instrument is recommended.

● Connecting via USB Cable

Connect the instrument to a computer with the supplied USB cable IF-A28 (2 m).

Notes

- To connect the instrument to a computer, the dedicated USB driver must be installed. The necessary drivers will be installed automatically. To install the drivers manually, use the drivers included with the software (such as the optional Color Data Software SpectraMagic NX2).
- The instrument can be powered through the USB cable. (The battery must always be installed.)
- When power is being supplied via USB, the charging lamp on the instrument's panel will light up orange while charging. When charging is complete, the lamp will turn green.
- Firmly connect the USB connector plug in the correct orientation.
- When connecting/disconnecting the USB cable, be sure to hold the connector plug. Do not pull on or forcibly bend the cable. Otherwise, wire breakage may result.
- Connect the instrument using a cable with a suitable length. Putting tension on the cable may cause connection failure or wire breakage.
- Firmly push in the USB cable connector that matches the shape of the port (connection terminal) until it can go in no further.

Memo

The USB communication port of the instrument conforms to USB 2.0.

Operating Procedure

- 1 Open the connector's protective cover, and connect the USB cable mini plug to the USB port on the instrument.**

- ◆ Fully insert the connector and ensure the connection is secure.

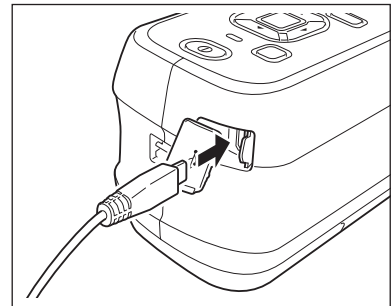

- 2 Connect the A connector of the USB cable to the USB port on the computer.**

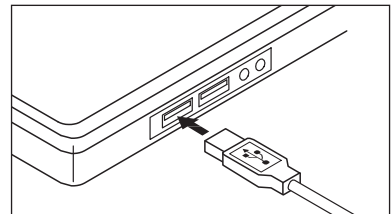

- 3 Turn the instrument power ON.**

- ◆ When installation of a USB driver is prompted, specify the USB driver included with your PC software to complete the installation.

● Connecting Via Wireless LAN/Bluetooth

Connect the instrument to a computer with wireless LAN or Bluetooth communication capabilities using the optional WLAN/Bluetooth module.

Notes

- The instrument's Bluetooth function enables data communication with a connected computer and printing from a Bluetooth printer. Connecting to both a computer and a printer/barcode reader at the same time, however, is not possible.
- A simultaneous connection via the USB cable and the wireless communication function is not possible.

Memo

To connect the instrument to a computer via the wireless LAN/Bluetooth function, appropriate preparations for wireless LAN/Bluetooth communication must be performed in advance for both the instrument and the computer.

○ Instrument Preparation

Connect the optional WLAN/Bluetooth module CM-A300.

Use the <Communication setup> screen of the instrument or the Spectrophotometer Configuration Tool CM-CT1 to configure wireless communication settings, and then turn ON the instrument's wireless communication function.

● Connecting the WLAN/Bluetooth Module

Operating Procedure

1 Slide open the instrument's battery cover and attach the WLAN/Bluetooth module.

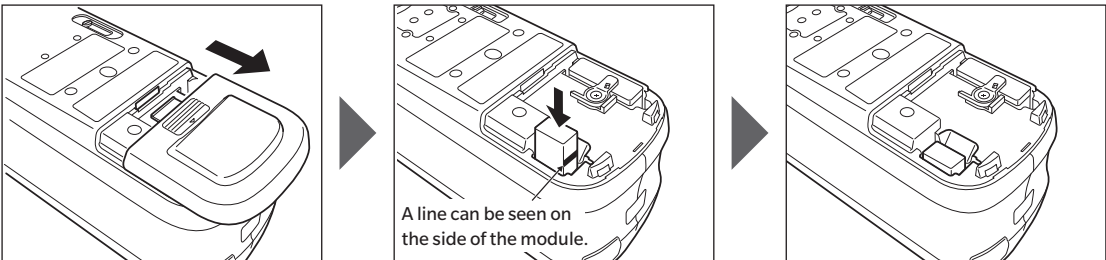

Notes

When inserting the WLAN/Bluetooth module, please note that the module will be slightly loose. Pushing forcibly on the module may damage the connector if the module and the connector on the instrument are not aligned correctly. The module and the connector on the instrument will be aligned correctly if the line on the side of the module is no longer visible when the module is dropped into the slot. Push the module in from this position until it clicks (approx. 1 mm).

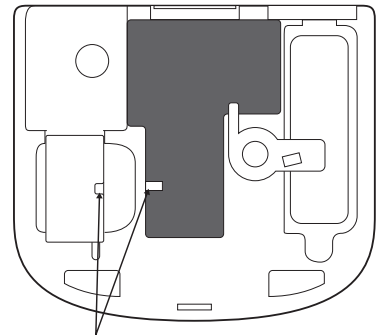

Insert with the orientation aligned to this position.

2 Slide the battery cover to close it.

■ Communication Setup (When Using Bluetooth)

Select the Bluetooth function and configure the meter PIN code.

Operating Procedure

Start the procedure from the measurement screen.

- 1 Press [MENU], and then use [◀] or [▶] to display the <Setting> screen.

Memo To return to the previous screen, press [MENU] or [ESC].

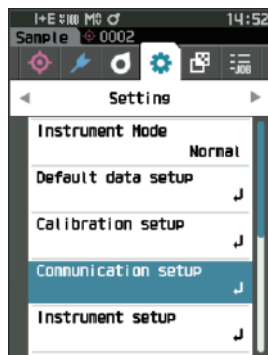

- 2 Use [▲] or [▼] to move the cursor to "Communication setup", and then press the [Confirmation] key.

The <Communication setup> screen is displayed.



□ Bluetooth Function Settings

Memo The wireless communication function is set to "OFF" when the instrument is shipped from the factory.

Operating Procedure

Start the procedure from the <Setting> - <Communication setup> screen.

- 1 Use [▲] or [▼] to move the cursor to "Wireless Setting", and then press the [Confirmation] key.

The <Wireless Setting> screen is displayed.



2 Use [▲] or [▼] to move the cursor to “Bluetooth”, and then press the [Confirmation] key.

When set to “Bluetooth”, the instrument’s Bluetooth function is turned ON and the display will return to the **<Communication setup> screen**. The Bluetooth icon will be displayed in the status bar.

To configure the Bluetooth PIN code, go to step 3.

Memo The Bluetooth PIN code can also be set using the CM-CT1 spectrophotometer setup tool. For details, refer to the instruction manual of the CM-CT1.

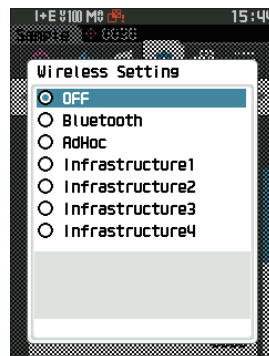

3 Use [▲] or [▼] to move the cursor to “Meter PIN code”, and then press the [Confirmation] key.

The **<PIN code setting> screen** is displayed.

- The initial personal identification number (PIN) code is “0000”.



4 Use [▲], [▼], [◀], or [▶] to select the value for the PIN code, and then press the [Confirmation] key to input each value.

The PIN should consist of between four and eight numbers (0 to 9).

5 After inputting the value, move the cursor to [OK] and press the [Confirmation] key.

The display will return to the **<Communication setup> screen**.



○ Connecting to a Computer

With the computer as a host, a connection to the instrument can be established using Bluetooth communication.

Operating Procedure

- 1 Verify that the instrument power has been turned ON.**
- 2 Open the Bluetooth and device settings screen on the computer.**

Notes If your computer uses Windows® 11, go to [Start] > [Settings] > [Bluetooth and Devices] > [Devices] and change the device detection setting from “Default” to “Advanced”.

- 3 Search for nearby Bluetooth devices, and select “CM26dG_XXXXXXXX” from the list of displayed devices. (XXXXXXXX indicates the serial number. For the CM-26d, select “CM26d_XXXXXXXX”. For the CM-25d, select “CM25d_XXXXXXXX”.)**
- 4 Enter the PIN code for the instrument (refer to step 4 on P.125) on the computer.**
- 5 Open the Bluetooth serial port to connections.**

Once the connection has been established, the “Communication ON” icon will be displayed in the status bar on the instrument.

■ Communication Setup (When Using Wireless LAN Function: Ad Hoc Method)

First, register the IP address and authentication key information to the instrument using the CM-CT1 spectrophotometer setup tool. For details, refer to the instruction manual of the CM-CT1.

Memo Information such as the IP address registered to the instrument can be viewed on the instrument's <Setting> - <Communication setup> - <WLAN Info.> screen.

Next, select the "AdHoc" method for the wireless LAN function to connect to your computer.

Operating Procedure Start the procedure from the measurement screen.

1 Press [MENU], and then use [◀] or [▶] to display the <Setting> screen.

Memo To return to the previous screen, press [MENU] or [ESC].

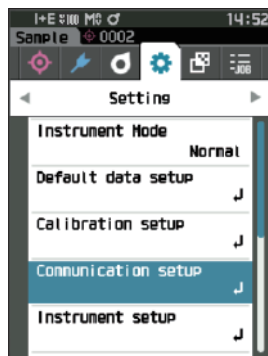

2 Use [▲] or [▼] to move the cursor to "Communication setup", and then press the [Confirmation] key.

The <Communication setup> screen is displayed.



□ Wireless LAN Function: Ad Hoc Method Settings

Memo

The wireless communication function is set to "OFF" when the instrument is shipped from the factory.

Operating Procedure

Start the procedure from the <Setting> - <Communication setup> screen.

- 1 Use [▲] or [▼] to move the cursor to "Wireless Setting", and then press the [Confirmation] key.

The <Wireless Setting> screen is displayed.

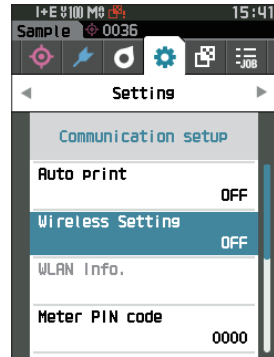

- 2 Use [▲] or [▼] to move the cursor to "AdHoc", and then press the [Confirmation] key.

When set to the Ad Hoc method, the instrument's wireless LAN function is turned ON and the display will return to the <Communication setup> screen. The wireless LAN icon will be displayed in the status bar.

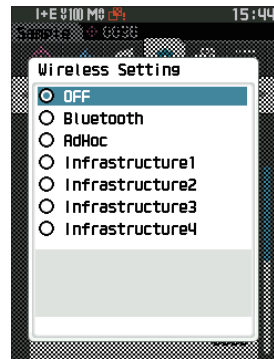

○ Connecting to a Computer

With the computer as a host, a connection to the instrument can be established using wireless LAN communication.

Operating Procedure

- 1 Verify that the instrument power has been turned ON.
- 2 Verify that the wireless LAN function on the instrument has been turned ON.
- 3 Open the available networks screen on the computer.
- 4 The connection destination is displayed with the instrument name and serial number as ID. Select it and click on it.
- 5 On your computer, connect the instrument to the wireless LAN network using the optional Color Data Software SpectraMagic NX2. For details, refer to the instruction manual of SpectraMagic NX2.

Once the connection has been established, the "Communication ON" icon will be displayed in the status bar on the instrument.

■ Communication Setup (When Using Wireless LAN)

Function: Infrastructure Method

First, register the access point information to the instrument using the CM-CT1 spectrophotometer setup tool. For details, refer to the instruction manual of the CM-CT1.

Memo Information such as the access point and IP address registered to the instrument can be viewed on the instrument's <Setting> - <Communication setup> - <WLAN Info.> screen.

Next, select the "Infrastructure" method for the wireless LAN function to connect to your computer.

Operating Procedure

Start the procedure from the measurement screen.

- 1 Press [MENU], and then use [◀] or [▶] to display the <Setting> screen.

Memo To return to the previous screen, press [MENU] or [ESC].



- 2 Use [▲] or [▼] to move the cursor to "Communication setup", and then press the [Confirmation] key.

The <Communication setup> screen is displayed.



□ Wireless LAN Function: Infrastructure Method Settings

Memo

The wireless communication function is set to "OFF" when the instrument is shipped from the factory.

Operating Procedure

Start the procedure from the <Setting> - <Communication setup> screen.

- 1 Use [▲] or [▼] to move the cursor to "Wireless Setting", and then press the [Confirmation] key.

The <Wireless Setting> screen is displayed.

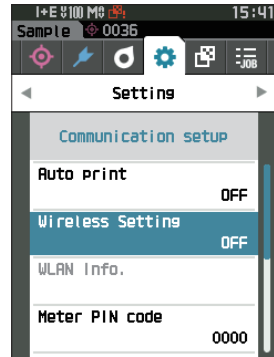

- 2 Use [▲] or [▼] to move the cursor to one of "Infrastructure1" to "Infrastructure4", and then press the [Confirmation] key.

When set to an Infrastructure method, the connection between the device and the access point is established, the instrument's wireless LAN function is turned ON, and the display will return to the <Communication setup> screen. The wireless LAN icon will be displayed in the status bar.

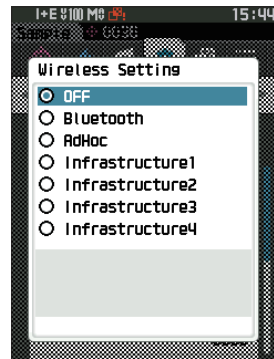

○ Connecting to a Computer

With the computer as a host, a connection to the instrument can be established using wireless LAN communication.

Operating Procedure

- 1 Verify that the instrument power has been turned ON.
- 2 Verify that the wireless LAN function on the instrument has been turned ON.
- 3 Verify that the connection between the computer and the access point has been established.
- 4 On your computer, connect the instrument to the wireless LAN network using the optional Color Data Software SpectraMagic NX2. For details, refer to the instruction manual of SpectraMagic NX2.

Once the connection has been established, the "Communication ON" icon will be displayed in the status bar on the instrument.

○ Connecting to a Printer/Barcode Reader

Connecting the instrument to a printer or barcode reader via the Bluetooth function enables printing of various data such as measurement results or scanning of names for data to save to the instrument.

Notes

- **With the optional accessory CM-A300 WLAN / Bluetooth module installed, the Bluetooth function of this instrument enables data communication to a computer, data printing to the bluetooth printer, and reading of data names from a barcode reader. However, connecting to both the Bluetooth module and a computer is not possible.**
- **Printing is possible at distances up to 10 m, but the distance at which operation can be performed properly depends on the wireless environment around the device.**
- **The instrument can only output text to the printer. Note that even if spectral graphs, color difference graphs, or other graphics are selected in the display type of the instrument, no graph will be printed.**

Memo

- To connect the instrument to a printer or barcode reader via the Bluetooth function, appropriate preparations for Bluetooth communication must be performed in advance for both the instrument and the printer or barcode reader.
- Bluetooth communication with the instrument supports the Serial Port Profile (SPP).
Note that some printers and barcode readers may not operate correctly even if SPP is supported. Use equipment recommended by a KONICA MINOLTA-authorized service facility.

○ Printer/Barcode Reader Preparation

The following section describes the preparations required for ensuring that the instrument recognizes the bluetooth printer or a barcode reader as a Bluetooth device.

Notes

This section describes general procedures. For more information, please refer to the instruction manuals included with the Bluetooth printer and the barcode reader.

Operating Procedure

1 Ensure use of the Bluetooth printer / barcode reader is possible.

- ◆ Verify that the printer/barcode reader communication mode is set to Bluetooth. In addition, charge the battery and load printer paper as required.

2 Verify the Bluetooth address and PIN code of the printer/barcode reader.

○ Instrument Preparation

Connect the WLAN / Bluetooth module to the instrument, and then set the instrument's wireless communication function to Bluetooth. (Refer to P.123.)

Notes Until the instrument's wireless communication function is set to Bluetooth, registration and automatic printing configuration of the Bluetooth printer/reader is not possible.

Memo The Bluetooth address and Bluetooth PIN code can also be set using the Spectrophotometer Configuration Tool CM-CT1. For details, refer to the CM-CT1 manual.

□ Registering a Bluetooth Address

Operating Procedure

Start the procedure from the <Setting> - <Communication setup> screen.

- 1 Use [▲] or [▼] to move the cursor to "Printer address" / "Scanner address", and then press the [Confirmation] key.

The <Printer address> / <Scanner address> screen is displayed.

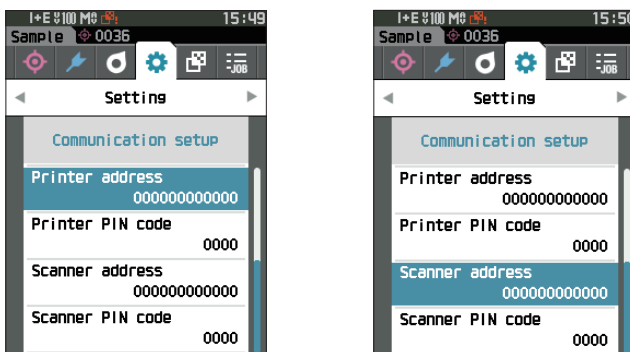

- 2 Enter the address of the Bluetooth device to be connected.

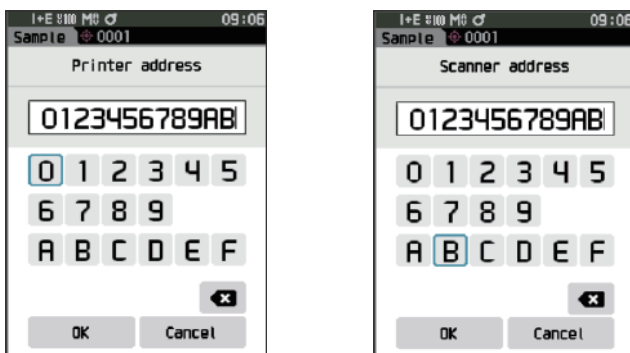

- 3 After inputting the characters, move the cursor to [OK] and press the [Confirmation] key.

The printer/barcode reader will be registered as an I/O device for the instrument, and the display will return to the <Communication setup> screen.

Memo If [ESC] is pressed during configuration, or if the cursor is moved to "Cancel" and the [Confirmation] key is pressed, the settings will not be changed, and the screen will return to the <Communication setup> screen.

PIN Code Configuration

Enter the PIN set for the printer/barcode reader (already confirmed).

Operating Procedure

Start the procedure from the <Setting> - <Communication setup> screen.

- 1 Use [▲] or [▼] to move the cursor to “Printer PIN code” or “Scanner PIN code”, and then press the [Confirmation] key.

- The initial personal identification number (PIN) code is “0000”.

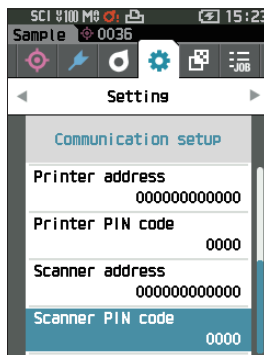
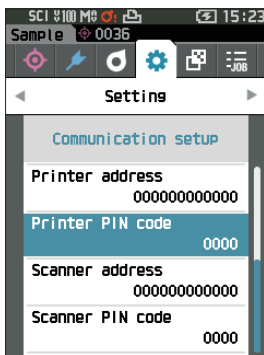

- 2 Use [▲], [▼], [◀], or [▶] to enter the PIN code.

- The PIN should consist of between four and eight numbers (0 to 9).

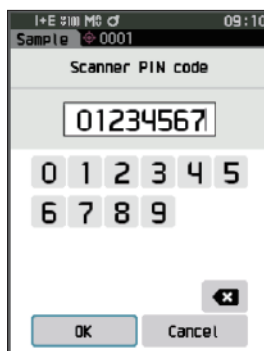
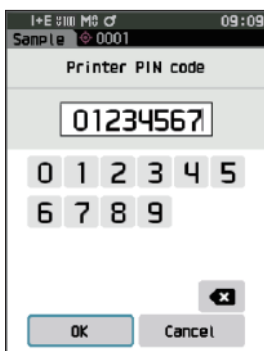

- 3 After inputting the value, move the cursor to [OK] and press the [Confirmation] key.

The printer/barcode reader will be connectable as an I/O device for the instrument, and the display will return to the <Communication setup> screen.

Memo If [ESC] is pressed during configuration, or if the cursor is moved to “Cancel” and the [Confirmation] key is pressed, the settings will not be changed, and the screen will return to the <Communication setup> screen.

□ Printing Data

Print the sample or target data with the printer.

Notes

- The instrument must be connected to the printer in advance.
- The instrument can only output text to the printer. Note that even if spectral graphs, color difference graphs, or other graphics are selected in the display type of the instrument, no graph will be printed.

Operating Procedure

Start the procedure from the <Target> or <Sample> screen.

- 1 To print the target and sample display, press the [MENU] key with the data to be printed displayed. The <Target menu> screen or the <Sample menu> screen will be displayed.

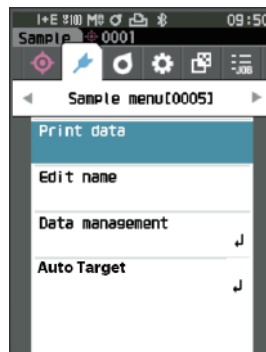

- 2 Use [▲] or [▼] to move the cursor to "Print data".

Press the [Confirmation] key to display the <Print> screen and print the data from the connected printer.

- When the printing is complete, the screen returns to the <Target> / <Sample> screen.

□ Auto Print

Measurement results can be automatically printed for every measurement.

Notes

- The instrument must be connected to the printer in advance.
- The instrument can only output text to the printer. Note that even if spectral graphs, color difference graphs, or other graphics are selected in the display type of the instrument, no graph will be printed.

Memo

Auto print is set to "OFF" when the instrument is shipped from the factory.

Operating Procedure

Start the procedure from the <Setting> - <Communication setup> screen.

- 1 Use [▲] or [▼] to move the cursor to "Auto print", and then press the [Confirmation] key.

The <Auto print> screen is displayed.

- 2 Use [▲] or [▼] to move the cursor to "ON", and then press the [Confirmation] key.

The Auto Print function will turn ON, and printing will be performed every time measurement is performed.

After the settings have been configured, the display will return to the <Communication setup> screen.

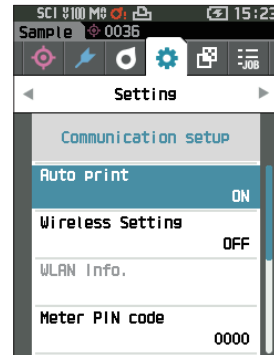

Print Example 1

Display type set to "Spectral Graph"

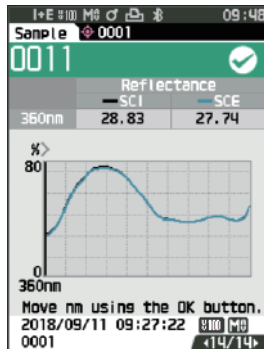

```

S/N 1000103
SAMPLE0011 PASS

          SCI
360nm 28.83 560nm 48.80
370nm 31.03 570nm 41.93
530nm 60.74 730nm 41.90
540nm 56.24 740nm 40.02
550nm 51.09

          SCE
360nm 27.74 560nm 44.82
370nm 29.93 570nm 40.97

530nm 59.63 730nm 40.75
540nm 55.14 740nm 47.83
550nm 50.06

2018/08/08 12:32:14 MAV
TARGET0001 UV100%
    
```

Print Example 2

Display type set to "Diff. Graph"

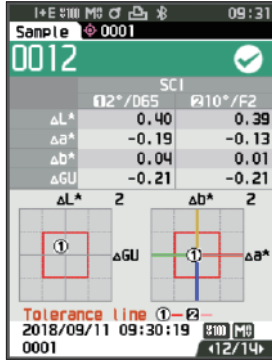

```

S/N 10000103
SAMPLE0012 PASS

      2/D65   10/F2
      SCI
dL*  -0.40  -0.39
da*  -0.19  -0.13
db*  -0.04  -0.01
dE*ab 0.44  0.41
MI    0.06  0.06

      SCE
dL*  -0.37  -0.10
da*  -0.19  -0.14
db*   0.06   0.04
dE*ab 0.42  0.40
dGU  -0.21  -0.21
MI    0.06  0.06
2018/08/06 13:40:41 MAV
TARGET0001  UV100%
    
```

Memo/ If the color difference result is "Fail", an "x" will be printed after the value.
If the value approaches the tolerance, "w" is appended after the value.

Print Example 3

Display type set to "Abs. & Diff."

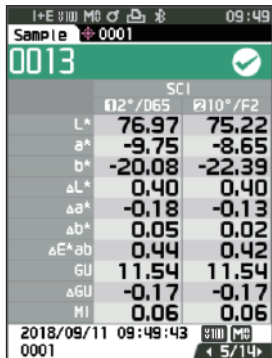

```

S/N 10000103
SAMPLE0013 PASS

      2/D65   10/F2
      SCI
L*   76.97  75.22
a*   -9.75  -8.65
b*  -20.08 -22.39
dL*   0.40   0.40
da*  -0.18  -0.13
db*   0.05   0.02
dE*ab 0.44  0.42
dGU  -0.17  -0.17
MI    0.06  0.06

      SCE
L*   76.33  74.57
a*   -9.85  -8.73
b*  -20.11 -22.42
dL*   0.37   0.36
da*  -0.19  -0.14
db*   0.07   0.05
dE*ab 0.42  0.39
GU   11.54  11.54
dGU  -0.17  -0.17
MI    0.06  0.06
2018/08/08 12:32:08 MAV
TARGET0001  UV100%
    
```

Print Example 4

Opacity measurement

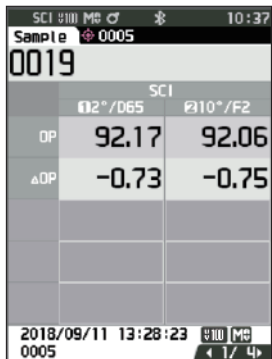

```

S/N 10000103
SAMPLE0019

      2/D65   10/F2
      SCI
OP   92.17  92.06
dOP  -0.73  -0.75
2018/08/07 13:49:22 MAV
TARGET0005  UV100%
    
```

Items marked with are not displayed with the CM-25d.

System Settings

This section explains how to configure calibration, how to display the instrument diagnosis info., and how to display the instrument info.

Operating Procedure

Start the procedure from the measurement screen.

- 1 Press [MENU], and then use [◀] or [▶] to display the <Setting> screen.

Memo To return to the previous screen, press [MENU] or [ESC].

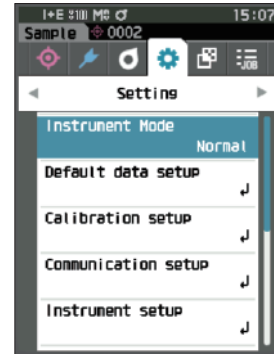

Calibration setup

Configure the instrument calibration settings.

Operating Procedure

Start the procedure from the <Setting> screen.

- 1 Use [▲] or [▼] to move the cursor to "Calibration setup", and then press the [Confirmation] key.

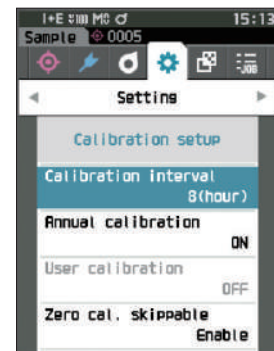
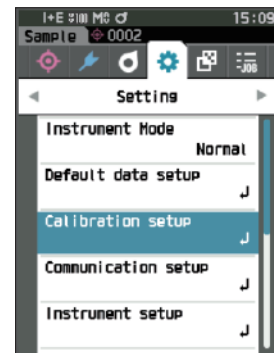

□ Calibration Interval Messages

If the instrument has not been used for an extended period of time since the previous measurement, a message prompting white calibration will appear after start-up and before measurement. The time interval between the previous calibration and when the message is displayed can be configured.

Memo The interval until the calibration is displayed is set to “8 hours” when the instrument is shipped from the factory.

Operating Procedure

Start the procedure from the <Calibration setup> screen.

- 1 Use [▲] or [▼] to move the cursor to “Calibration interval”, and then press the [Confirmation] key.

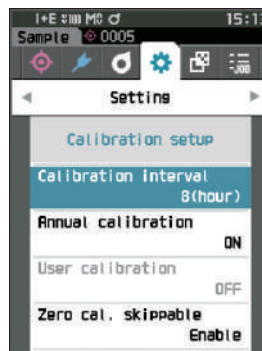

- 2 ▲ and ▼ will be displayed above and below the numbers representing the time until the message is displayed. Use [▲] or [▼] to specify a value.

Settings

- 1 to 24 h: Set the time interval between the previous calibration and when the message should be displayed to between 1 and 24 hours.



- 3 Press the [Confirmation] key.

The selection is confirmed and the screen returns to the <Calibration setup> screen.

Notes If [ESC] is pressed without pressing the [Confirmation] key, the settings will not be changed and the screen will return to the <Calibration setup> screen.

□ Annual Calibration Messages

As the time for periodic calibration approaches, the instrument shows a message reading “Regularly scheduled device calibration is required. Please contact the nearest service center.” at start-up to recommend annual service recalibration.

The annual calibration message can be set to be shown or to be hidden when the recommended recalibration time comes.

Notes Regardless of displaying annual calibration message, it is recommended to request regular calibration through our service department.

Memo Display of the annual calibration message is set to “ON (Display)” when the instrument is shipped from the factory.

Operating Procedure

Start the procedure from the <Setting> - <Calibration setup> screen.

1 Press [MENU].

The <Annual calibration> screen is displayed.

Settings

- OFF : The message about annual calibration will not be displayed.
- ON : The message about annual calibration will be displayed.

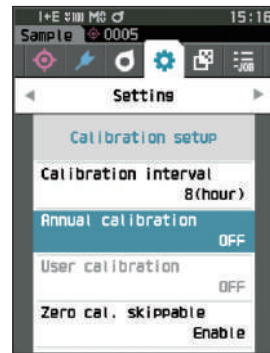

2 Use [◀] or [▶] to move the cursor to select “OFF” or “ON”.

Memo If the annual calibration notification message is set to ON, the annual calibration message will be displayed as the specified day nears. The date of the next calibration is specified upon initial startup or during KONICA MINOLTA calibration service (or maintenance) and cannot be changed.

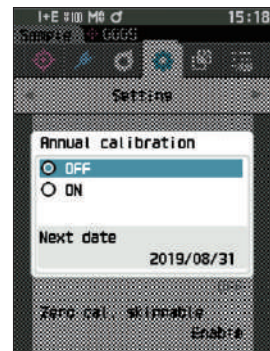

3 Press the [Confirmation] key.

The selection is confirmed and the screen returns to the <Setting> screen.

Notes If [ESC] is pressed without pressing the [Confirmation] key, the settings will not be changed and the screen will return to the <Setting> screen.

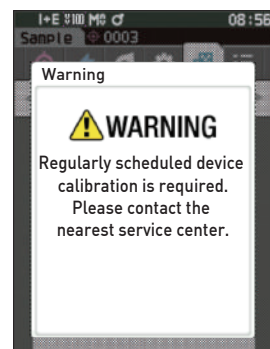

□ User calibration

You can perform calibration by using your own reference plate and calibration data instead of white calibration. The calibration data for user calibration can be specified by connecting the instrument to a computer and using the optional Color Data Software “SpectraMagic NX2”. Users can select whether to use the user calibration data for measurement.

Operating Procedure

Start the procedure from the <Setting> - <Calibration setup> screen.

1 Press [MENU].

The <User calibration> screen is displayed.

Settings

- OFF : User calibration cannot be performed.
- ON : User calibration can be performed.

2 Use [◀], [▲], [▶], or [▼] to move the cursor to select “OFF” or “ON”.



3 Press the [Confirmation] key.

The selection is confirmed and the screen returns to the <Calibration setup> screen.

Notes If [ESC] is pressed without pressing the [Confirmation] key, the settings will not be changed and the screen will return to the <Calibration setup> screen.

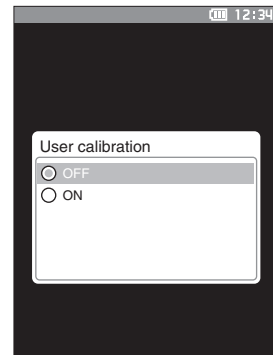

□ Zero calibration skip

When shipped from the factory, the “Calibration (Excluding Zero Cal.)” button is enabled on the <Calibration> screen. If configuring to ensure that zero calibration is performed, disable this function.

Memo Zero calculation skippable is set to “Disable (Perform zero calibration)” when the instrument is shipped from the factory.

Notes When using the MAV target mask (with glass), it is necessary to set “Zero cal. skippable” to “Disable” because the amount of stray light tends to fluctuate.

Operating Procedure

Start the procedure from the <Setting> - <Calibration setup> screen.

- 1 Use [▲] or [▼] to move the cursor to “Zero cal. skippable”, and then press the [Confirmation] key.

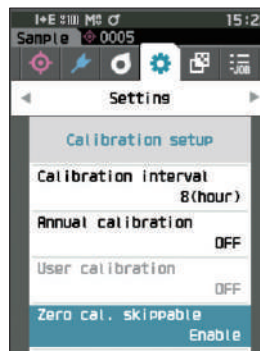

- 2 Use [▲] or [▼] to move the cursor to select “Disable” or “Enable”.



- 3 Press the [Confirmation] key.

The selection is confirmed and the screen returns to the <Calibration setup> screen.

Notes If [ESC] is pressed without pressing the [Confirmation] key, the settings will not be changed and the screen will return to the <Calibration setup> screen.

■ Displaying Diagnosis Info.

The results of the instrument status diagnosis using optional PC software are displayed.
(* Support for this function is planned with optional PC software. It is not currently available.)

Operating Procedure

Start the procedure from the <Setting> screen.

- 1 Use [▲] or [▼] to move the cursor to “Diagnosis info.,” and then press the [Confirmation] key.



- 2 The instrument status is diagnosed and the results are displayed.

Display

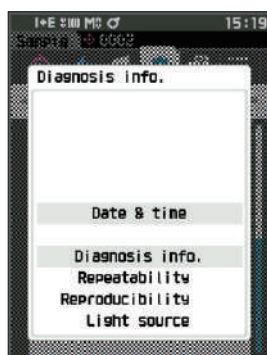

- 3 Press [ESC].

The display will return to the <Setting> screen.

■ Displaying the Instrument Information

Display the product name, version, and serial number of the instrument.

Operating Procedure

Start the procedure from the <Setting> screen.

- 1 Use [▲] or [▼] to move the cursor to “Instrument info.,” and then press the [Confirmation] key.



- 2 The instrument information is displayed.

Display Items

- Product name: Instrument product name
- Version: Instrument firmware version
- Serial No.: Instrument serial No.



- 3 Press [ESC].

The display will return to the <Setting> screen.

JOB Function

Administrators can pre-register to the instrument workflows to be performed by the worker, allowing the worker to perform measurement according to the registered workflow. This selection screen is available when the job has been set in advance with the optional Color Data Software SpectraMagic NX2.

- Notes**
- **Communication via USB is recommended when configuring JOB settings using the optional Color Data Software SpectraMagic NX2. Configuration of the JOB function is possible via wireless communication, but transferring settings and images between the computer and the measuring instrument will take time.**
 - **Exiting JOB mode will cause the observation conditions under JOB settings to be reset and the main unit's observation conditions to be restored. As such, if the JOB setting observation conditions differ from the main unit observation conditions, pass/fail results may differ between during JOB execution and after exiting the mode.**

Operating Procedure Start the procedure from the measurement screen.

1 Press [MENU], and then use [◀] or [▶] to display the <JOB> screen.

Memo To return to the previous screen, press [MENU] or [ESC].

2 Use [▲] or [▼] to move the cursor to the job to be used.

3 Follow the on-screen instructions to perform measurement.

- Notes**
- **Up to 5 types of jobs can be registered.**
 - **Calibration according to the measurement conditions being used within the job must be performed in advance.**
 - **Opacity measurement cannot be performed while in JOB mode.**



The operations for the various keys on the instrument are as follows.

- [▲] / [▼] key ... Used to switch the data display type (SCI, SCE, or Pass or Fail).
- [◀] / [▶] ... Used to select the Option Item.
- [Confirmation] key... Used to execute the Option Item selected by the cursor.
- [Target/Sample] key ...
Operation step : Disabled
Result step : Disabled
- [Menu] ... Disabled
- [ESC] key ... Used to end a job in progress through a warning message. Users can select "YES" or "NO" for the warning. Selecting "YES" will cause the screen to return to the JOB selection screen. Selecting "NO" will maintain the current step.
- [MES] key ...
Operation step : Performs measurement and moves to the next step.
Result step : Moves to the next step.

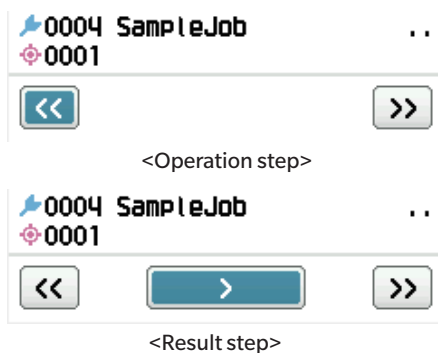

- << ... Moves to the previous step. When returning to the Operation step, the data measured in the Operation step will be discarded, so performing measurement again will be necessary.
- > ... Moves to the next step. This key is not displayed in the Operation step.
- >> ... Moves to the next Operation step.

MEMO

Chapter 5

Troubleshooting

Message List.....	147
Troubleshooting	149

Message List

Error message: The operation is not correct. Follow the instructions displayed immediately.

ER1_32	There was an error with color measurement device. Restart and try measuring again. If the error occurs again, please contact the nearest service center.
ER1_33	There was an error with the gloss measurement device. Restart and try measuring again. If the error occurs again, please contact the nearest service center.
ER1_34	There is no xenon output. Restart and try measuring again. If the error occurs again, please contact the nearest service center.
ER1_35	There is no LED output. Restart and try measuring again. If the error occurs again, please contact the nearest service center.
ER1_36	The battery status cannot be obtained. Please contact the nearest service center.
ER1_39	There was an error writing to the memory. Restart and try again. If the error occurs again, please contact the nearest service center.
ER1_40	A memory error has occurred. Please contact the nearest service center.
ER1_41	The USB device is not working. Restart the device. If the error occurs again, please contact the nearest service center.
ER1_42	The USB host is not working. Restart the device. If the error occurs again, please contact the nearest service center.
ER1_43	An error has occurred with the clock IC. Please contact the nearest service center.
ER1_47	Connection to the printer failed. Please check the power and the settings.
ER1_55	The wireless module is not installed. Please check the wireless module is installed.
ER1_56	The wireless module not recognised. Attach the correct wireless module.
ER1_57	Wireless connection failed. Restart the device. Please check the wireless settings.

Warning: Continued use will result in incorrect operation. Follow the instructions displayed as soon as possible.

ER1_31	The power supply voltage is insufficient. Please charge.
WR1_1	The power supply voltage is low. Please charge.
WR1_3	Xenon output has dropped. Replacement is recommended.
WR1_4	The LED output has dropped. Replacement is recommended.
WR1_7	The battery is low. Replace the battery.

Caution: The setting or operation is not correct.

ER1_5	The target mask is wrong.	
ER1_15	The target is protected.	See P.69
ER1_18	The data could not be calculated.	
ER1_19	Data is outside the range of guaranteed performance.	
ER1_20	The input data is incorrect.	
ER1_21	No target was found.	
ER1_22	The measurement variation exceeds the threshold. Measure again.	
ER1_23	You have reached the maximum number of possible measurements.	
ER1_25	Cannot be used in the current mode.	
ER1_26	This sample cannot be referenced to the selected target.	
ER1_45	Only administrators can control this function.	See P.109
ER1_48	The date is incorrect.	See P.112
ER1_49	The set tolerance range is incorrect. Please check the upper and lower limits.	P.72 and 81.
WR1_8	Please retry the measurement. Press the measurement button to measure and update to the most recent data.	

Display: The flow of operation is displayed. Perform the operation according to the information displayed.

ER1_1	Regularly scheduled device calibration is required. Please contact the nearest service center.	See P.139
ER1_2	Regularly scheduled device calibration is approaching. Please contact the nearest service center.	See P.139
ER1_3	Please set the instrument on the zero calibration box and calibrate.	See P.35
ER1_4	Perform zero calibration.	See P.35
ER1_6	Please set the instrument on the white calibration plate and calibrate.	See P.37
ER1_7	Perform white calibration.	See P.37
ER1_8	Configure the white calibration data.	See P.37
ER1_9	Please set the instrument on the gloss calibration plate and calibrate.	See P.38
ER1_10	Perform gloss calibration.	See P.38
ER1_11	Configure the gloss calibration data.	See P.37
ER1_12	Please set the instrument on the user calibration plate and calibrate.	See P.39
ER1_13	Perform user calibration.	See P.39
ER1_14	Configure the user calibration data.	See P.39
ER1_16	The device memory is full. Please delete some data to measure.	P.41 and 53.
ER1_17	Specify at least one.	
ER1_24	Please change the measurement area.	
ER1_38	Please close the viewfinder.	See P.40
ER1_50	Calibration is required. Would you like to calibrate now?	See P.35
WR1_9	Data is being saved. Please wait until the power turns off.	
WR1_10	Data is being processed. Please wait.	
WR1_2	Calibration is recommended. Would you like to calibrate now?	P.35 and 138.

Troubleshooting

If an abnormality has occurred with the instrument, take the necessary actions as given in the table below. If the instrument still does not work properly, turn the power OFF and temporarily disconnect the battery. Reinsert the battery and turn the power back ON. If the symptom remains, contact a KONICA MINOLTA-authorized service facility.

Symptom	Check Point	Action
The instrument does not start up even though the power is ON, or it turns off immediately.	Has the battery been inserted correctly? Is the battery dead?	Insert the battery correctly, or use the AC adapter or USB bus power to charge the battery.
Measurement cannot be performed even by pressing the measurement button.	Is measurement still in progress?	Wait until the beep indicates that measurement is complete, or verify that the LCD has changed before performing the operation. No beep can be heard.P.115 “Beep”, and check the beep settings.
	Is a screen where measurement is possible displayed?	The measurement button must be pressed while a screen that allows measurement (e.g. Calibration, Target, or Sample screen) is shown.
	Is the viewfinder open?	Use the viewfinder lever to securely close the viewfinder. If the inside of the integrating sphere is illuminated and shining, the viewfinder lever is not closed. Remove any foreign matter, etc. caught in the viewfinder lever components.
Measurement results are abnormal.	Is the specimen placed properly?	The measurement results may be affected if measurement light leaks. Set the instrument so that the sample is as close to the target mask surface as possible.
	Is there any foreign material on the surface of the target mask or around the specimen measuring surface?	Measurement results may be affected if foreign matter becomes caught between the specimen and the target mask surface. Clean the specimen surface or the target mask measurement surface according to the specified method.
	Are there marks on the surface of the target mask around the specimen measuring port?	If the sample and the target mask surface are not in contact due to a dent or the like, the measurement results may be affected. To replace the target mask, please contact a KONICA MINOLTA-authorized service facility.
	Is there foreign matter or other dirt adhering to the inside of the integrating sphere?	Foreign matter or dirt larger than several mm may affect the measurement results. Foreign matter and dust inside the integrating sphere can easily scratch the barium sulfate paint on the inside of the sphere. Use a blower to blow off those objects. If such objects cannot be removed with the blower, zero calibration and white calibration may improve performance.
	Is the target mask attached correctly? (CM-26d, CM-25d)	P.33Read “Replacing the Target Mask”, and attach the target mask correctly.
	Is proper calibration data used?	Calibration data is written to the instrument using the Spectrophotometer Configuration Tool CM-CT1. Verify that the calibration plate is correct for the input calibration data before performing white calibration, gloss calibration, or user calibration.
	Was white calibration performed correctly?	P.37Read “White Calibration and Gloss Calibration” to perform white calibration or gloss calibration properly.
	Was gloss calibration performed correctly?	
	Was zero calibration performed correctly?	P.35 “Zero calibration” and perform zero calibration properly.

Symptom	Check Point	Action
Measurement results fluctuate.	Is the instrument and specimen kept stationary during measurement?	Do not allow the instrument and specimen to move during measurement. Use averaging measurement as needed.
Data cannot be transferred to a computer from the instrument.	Is the USB cable connected correctly?	Properly connect the instrument's USB connecting terminal to the computer's USB port with the USB cable supplied with the instrument.
No commands from the computer are being accepted.	Has wireless LAN or Bluetooth communication been established?	Install and connect the WLAN / Bluetooth module correctly.
Printing is not possible.	Has Bluetooth communication been established?	Install and connect the WLAN / Bluetooth module correctly.
Samples and settings are not held in memory and disappear immediately.	The instrument's backup battery may be low immediately after purchase or following a period of prolonged non-use. Turn the instrument ON to charge the backup battery. Under this condition, the backup battery will be fully charged in 20 hours.	The backup battery in the instrument should last 10 years under normal use. If the instrument fails to retain data in memory even after the battery has been fully charged, however, the battery has likely reached the end of its life and requires replacement. To replace the backup battery, please contact a KONICA MINOLTA-authorized service facility.

MEMO

Chapter 6

Appendix

Fluorescence Measurement	153
Specifications	154
Dimensions	156

Fluorescence Measurement

This instrument features both a UV full xenon lamp and a UV cut xenon lamp. Fluorescence reflectance is calculated through numerical processing of the reflectance from these two light sources.

With fluorescence calibration

To ensure accurate fluorescence reflectance measurement, fluorescence calibration can be performed via SpectraMagic NX2.

Finding the fluorescence reflectance

The fluorescence amount is determined for each reflectance wavelength under both the UV full light source and the UV cut light source by measuring a fluorescence standard plate. The fluorescence correction coefficient is determined to ensure the measured values are matched to the given target values.

(Calibration example: Profile mode)

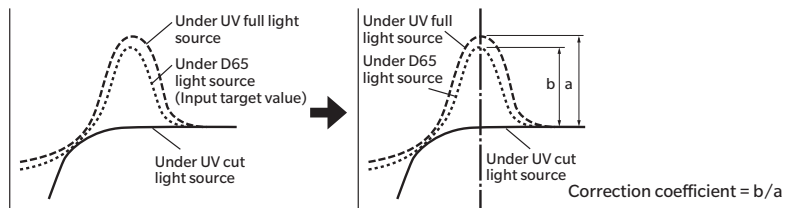

The fluorescence correction coefficient is used to determine the fluorescence reflectance through numerical processing of a measurement object's reflectance under the UV full light source and under the UV cut light source. (The reflectance of the cut wavelength region for UV cut lighting is uniform at 0%.)

This allows the instrument to approximate the output fluorescence amount under any reference light source, such as a D65 light source, without increasing or decreasing the amount of UV light as with conventional models.

Without fluorescence calibration

The spectral distribution characteristics of the instrument's UV full xenon lamp are close to that of a D65 light source, making it possible to measure fluorescence reflectance with ordinary reflectance measurement if strict accuracy is not required for the fluorescence measurement.

UV cut light source

This instrument is equipped with a UV 400 option as a UV cut light source (with all UV rays up to 390 nm eliminated).

Specifications

Model	CM-26dG	CM-26d	CM-25d	
Color	illumination/ viewing system	di: 8°, de: 8° (diffuse illumination: 8° viewing) SCI (specular component included) / SCE (specular component excluded) switchable Conforms to CIE No.15 (2004), ISO7724/1, ASTM E1164, DIN5033 Teil7, JIS Z 8722 Condition c standard		
	Integrating sphere	Ø54 mm		
	Detector	Dual 40-element silicon photodiode arrays		Dual 32-element silicon photodiode arrays
	Spectral separation device	Planar diffraction grating		
	Wavelength range	360 to 740 nm		400 to 700 nm
	Wavelength pitch	10 nm		
	Half bandwidth	Approx. 10 nm		
	Reflectance measurement range	0 to 175%; Display resolution: 0.01%		
	Light source	Pulsed xenon lamp ×2		Pulsed xenon lamp ×1 (with UV cut filter)
	Illumination area	12 × 12.5 mm (circle + ellipse)	MAV : Ø12 mm SAV : Ø6 mm	MAV : Ø12 mm
	Measurement area	MAV: Ø8 mm, SAV: Ø3 mm		MAV : Ø8 mm
	Repeatability	Standard deviation within ΔE*ab 0.02		Standard deviation within ΔE*ab 0.04
		(When a white calibration plate is measured 30 times at 5-second intervals after white calibration under Konica Minolta standard measurement conditions)		
	Inter-instrument agreement	Within ΔE*ab 0.12		Within ΔE*ab 0.2
		(Based on average for 12 BCRA Series II color tiles; MAV SCI; compared to values measured with a master body under Konica Minolta standard measurement conditions)		
	UV setting	100% / 0% / 100% + 0% / Adjusted (Instantaneous numerical adjustment of UV with no mechanical filter movement required)*1; 400 nm UV cutoff filter		No adjustment function (UV0%)
	Observer	2° observer angle, 10° observer angle		
	Illuminant*2	A, C, D50, D65, F2, F6, F7, F8, F10, F11, F12, ID50, ID65, LED-B1, LED-B2, LED-B3, LED-B4, LED-B5, LED-BH1, LED-RGB1, LED-V1, LED-V2, User-defined illuminant (Simultaneous evaluation with two light sources possible)		
	Display items	Colorimetric values/graph, color difference values/graph, spectral graph, pass/fail judgment, pseudocolor		
	Colorimetric values	L*a*b*, L*C*h, Hunter Lab, Yxy, XYZ, and color difference in these spaces; Munsell (C)		
Indices	MI, WI (ASTM E313-73), YI (ASTM E313-73, ASTM D1925), ISO brightness (ISO 2470), WI/Tint (CIE/Ganz), Tristimulus Strength, Opacity, Grey Scale (ISO 105-A05), K/S strength (Apparent (ΔE*ab)), Maximum absorption, Total wavelength), Staining degree (ISO 105-A04), User index*3	MI, W (I ASTM E313-73), YI (ASTM E313-73, ASTM D1925), ISO brightness (ISO 2470), WI/Tint (CIE/Ganz), Tristimulus Strength, Opacity, Grey Scale (ISO 105-A05), 8° gloss value, K/S strength (Apparent (ΔE*ab)), Maximum absorption, Total wavelength), Staining degree (ISO 105-A04), User index*3	MI, W (I ASTM E313-73), YI (ASTM E313-73, ASTM D1925), ISO brightness (ISO 2470), WI/Tint (CIE), Tristimulus Strength, Opacity, Grey Scale (ISO 105-A05), 8° gloss value, K/S strength (Apparent (ΔE*ab)), Maximum absorption, Total wavelength), Staining degree (ISO 105-A04), User index*3	
Color difference equations	ΔE*ab (CIE1976) / ΔE*94 (CIE1994) / ΔE00 (CIEDE2000) / CMC (l:c) / Hunter ΔE / DIN990 / FMC-2			

*1 Firmware version 1.10 or later and optional Color Data Software SpectraMagic NX2 Pro is required to use UV Adjusted setting.

*2 Optional Color Data Software SpectraMagic NX2 is required for setting user-configured illuminants. When selecting an LED light source as LED-B1 for the illuminant, if SpectraMagic NX2 is in use, it must be version 1.5 or later, and if Spectrophotometer Configuration Tool CM-CT1 is in use, it must be version 1.51 or later.

*3 CM-CT1 (Ver. 1.4 or later) and a valid SpectraMagic NX2 license are required for setting user indices.

Model		CM-26dG	CM-26d	CM-25d
Gloss	Measurement angle	60°	—	—
	Light source	White LED	—	—
	Detector	Silicon photodiode	—	—
	Color sensitivity	Spectrally adjusted to CIE photopic luminous efficiency $V(\lambda)$ under CIE illuminant C	—	—
	Measurement range	0 to 200 GU; Display resolution: 0.01 GU	—	—
	Measurement area	MAV : 10×7 mm, ellipse SAV : Ø3 mm	—	—
	Repeatability	Standard deviation 0 to 10 GU: Within 0.1 GU 10 to 100 GU: Within 0.2 GU 100 to 200 GU: Within 0.2% of indicated value (When measured 30 times at 5-second intervals after calibration under Konica Minolta standard measurement conditions)	—	—
	Inter-instrument agreement	0 to 10 GU: Within ±0.2 GU 10 to 100 GU: Within ±0.5 GU (MAV; compared to values measured with a master body under KONICA MINOLTA standard measurement conditions)	—	—
	Applicable standards	JIS Z8741 (MAV), JIS K5600, ISO 2813, ISO 7668 (MAV), ASTM D523-08, ASTM D2457-13, DIN 67530	—	—
Measurement time	Approx. 1 sec. (Measurement mode: SCI + Gloss or SCE + Gloss) (From pressing measuring button to measurement completion)	Approx. 0.7 sec. (Measurement mode: SCI or SCE)		
Minimum measurement interval	Approx. 2 sec (Measurement mode: SCI + gloss or SCE + gloss)	Approx. 1.5 sec (Measurement mode: SCI or SCE)		
Data memory	1,000 target data + 5,100 sample data			
Battery performance	Measurement mode: SCI + Gloss or SCE + Gloss	Measurement mode: SCI or SCE		
	Approx. 3,000 measurements (approx. 1,000 measurements when using Bluetooth) when measurements are taken at 10-second intervals at 23°C with the dedicated lithium battery			
Viewfinder function	Available (with white LED illumination)			
Display	2.7-inch TFT color LCD with reversible portrait viewing mode			
Display language	English, Japanese, German, French, Italian, Spanish, Simplified Chinese, Portuguese, Russian, Turkish, Polish			
Interface	USB 2.0 Bluetooth (SPP-compatible)* WLAN (802.11 a/b/g/n)* * Optional WLAN / Bluetooth module required WLAN security supports WPA2-PSK (WPA2-Personal) and WPA-PSK (WPA-Personal) for the AdHoc method, and WPA3-PSK (WPA3-Personal), WPA2-PSK (WPA2-Personal) and WPA-PSK (WPA-Personal) for the Infrastructure method.			
Power	Dedicated lithium-ion battery (removable), USB bus power (with lithium-ion battery installed), Dedicated AC adapter (with lithium-ion battery installed)			
Charging time	Approx. 6 h			
Operating temperature/humidity range	Temperature: 5 to 40°C, Relative humidity: 80% or less (at 35°C) with no condensation			
Storage Temperature/humidity range	Temperature: 0 to 45°C, Relative humidity: 80% or less (at 35°C) with no condensation			
Size	Approx. 81 (W) × 93 (H) × 229 (D) mm			
Weight	Approx. 660 g	Approx. 630 g	Approx. 620 g	

Dimensions

CM-26dG / CM-26d / CM-25d

(Unit: mm)

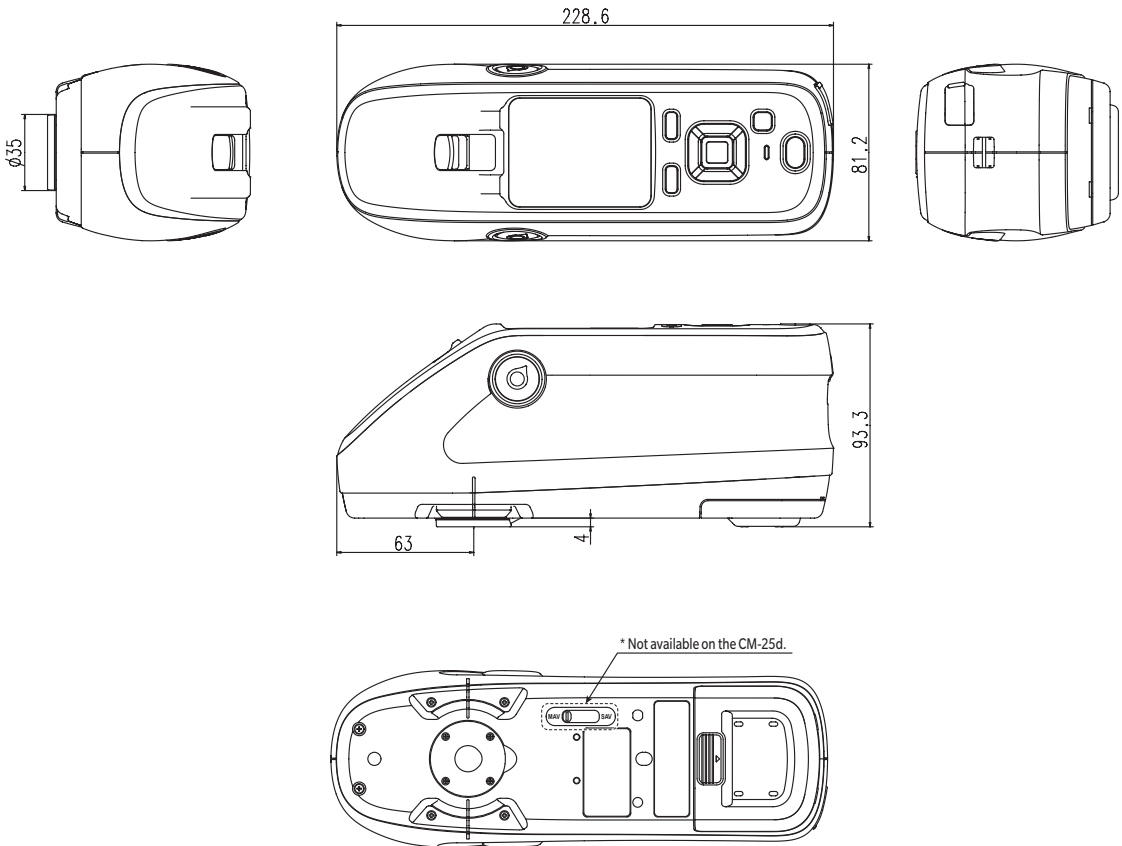

< CAUTION >

- KONICA MINOLTA WILL NOT BE LIABLE FOR ANY DAMAGES RESULTING FROM THE MISUSE, MISHANDLING, UNAUTHORIZED MODIFICATION, ETC. OF THIS PRODUCT, OR FOR ANY INDIRECT OR INCIDENTAL DAMAGES (INCLUDING BUT NOT LIMITED TO LOSS OF BUSINESS PROFITS, INTERRUPTION OF BUSINESS, ETC.) DUE TO THE USE OF OR INABILITY TO USE THIS PRODUCT.

User Equation and User Class

- The User Equation (User Index) function allows users to input an equation defined by the user and using values currently set for display on the instrument, and have the instrument show the results of the user-defined equation.
- The User Class function allows users to classify measurements into groups (such as grades or ranks) according to the results of a defined User Equation.

Registering a User Equation and/or User Class on the instrument

The User Equation and/or User Class can be registered on the instrument using Color Data Software SpectraMagic NX2.

- The User Class is defined based on the User Equation of the same number. For example, UC1 is defined based on UE1. If no User Equation is defined for the selected UC number, the User Class definition will not be used.

Displaying the results of a User Equation and/or User Class on the instrument

The calculated results for a User Equation and/or User Class can be displayed by selecting UE1 to UE3 (User Equation 1 to 3) and/or UC1 to UC3 (User Class 1 to 3) in a Custom screen of Display cond. on the instrument. (See Display Settings in the Instruction Manual for the instrument.)

Measurement values

The following measurement values can be used in User Equation.

- The measurement values to be used in the User Equation and **to be displayed on Custom screen** must be set to be displayed on the instrument in the Display type, Color space, Equation, or Custom screen of Display cond. on the instrument. (See Display Settings in the Instruction Manual for the instrument.)
- Measurement values not listed in the table below cannot be used.

L*	a*	b*	C*	h
L(Hunter)	a(Hunter)	b(Hunter)	X	Y
Z	x	y	GU	ΔL^*
Δa^*	Δb^*	ΔC^*	ΔH^*	$\Delta L(\text{Hunter})$
$\Delta a(\text{Hunter})$	$\Delta b(\text{Hunter})$	ΔX	ΔY	ΔZ
Δx	Δy	ΔGU	ΔE^*ab	CMC
ΔE^*94	$\Delta E00$	$\Delta E(\text{Hunter})$	MI	WI(E313-73)
$\Delta WI(\text{E313-73})$	WI(CIE)	$\Delta WI(\text{CIE})$	Tint(CIE)	$\Delta Tint(\text{CIE})$
YI(E313-73)	$\Delta YI(\text{E313-73})$	YI(D1925)	$\Delta YI(\text{D1925})$	B(ISO)
$\Delta B(\text{ISO})$				

Refer to **Input Format** below.

Functions

The following functions can be used in User Equation.

Mathematical functions	Trigonometric functions	Other functions
addition, subtraction, multiplication, division	sin, cos, tan, \sin^{-1} , \cos^{-1} , \tan^{-1}	square, square root, absolute value, logarithm, natural logarithm, exponent, power

Refer to **Input Format** below.

User Equation

Input example

To input the equation for ΔE^*ab

$$\Delta E^* ab = \sqrt{(\Delta L^*)^2 + (\Delta a^*)^2 + (\Delta b^*)^2}$$

as a User Equation, it would be:

SQRT(POW([DL])+POW([DA])+POW([DB]))

Input Format

A User Equation is defined using numbers and strings for measurement value variables and functions.

- Parameter strings are explained in **Input Format** below.
- The total length of a User Equation definition including numbers and string parameters is 200 characters.

Numerical constants

Numbers can be input as constants using 0 to 9 and the decimal point.

Although there is no limit on the number of decimal places that can be input, the number of significant digits for calculations is 5 places.

Measurement value variables

For CM-25cG

Variable	Measurement value	Variable	Measurement value	Variable	Measurement value
[L]	L*	[A]	a*	[B]	b*
[DL]	ΔL^*	[DA]	Δa^*	[DB]	Δb^*
[C]	C*	[H]	H		
[DC]	ΔC^*	[DH]	ΔH^*		
[HL]	L(Hunter)	[HA]	a(Hunter)	[HB]	b(Hunter)
[DHL]	ΔL (Hunter)	[DHA]	Δa (Hunter)	[DHB]	Δb (Hunter)
[X]	X	[Y]	Y	[Z]	Z
[DX]	ΔX	[DY]	ΔY	[DZ]	ΔZ
[SX]	x	[SY]	y		
[DSX]	Δx	[DSY]	Δy		
[GU]	GU	[DGU]	ΔGU		
[DE]	ΔE^*ab	[CMC]	CMC	[DE94]	ΔE^*94
[DE00]	$\Delta E00$	[DEH]	ΔE (Hunter)	[MI]	MI
[WIE]	WI E313-73	[WIC]	WI CIE	[TINT]	Tint CIE
[DEWI]	ΔWI E313-73	[DWIC]	ΔWI CIE	[DTINT]	$\Delta Tint$ CIE
[YIE]	YI E313-73	[YID]	YI D1925	[BISO]	B(ISO)
[DYIE]	ΔYI E313-73	[DYID]	ΔYI D1925	[DBISO]	ΔB (ISO)

For CM-26dG, CM-26d, CM-25d

Common variables

- Calculations will be performed using the SCI/SCE setting of the current screen. In the SCI screen, SCI values will be used and in the SCE screen, SCE values will be used.

Variable	Measurement value	Variable	Measurement value	Variable	Measurement value
[L]	L*	[A]	a*	[B]	b*
[DL]	ΔL^*	[DA]	Δa^*	[DB]	Δb^*
[C]	C*	[H]	H		
[DC]	ΔC^*	[DH]	ΔH^*		
[HL]	L(Hunter)	[HA]	a(Hunter)	[HB]	b(Hunter)
[DHL]	ΔL (Hunter)	[DHA]	Δa (Hunter)	[DHB]	Δb (Hunter)
[X]	X	[Y]	Y	[Z]	Z
[DX]	ΔX	[DY]	ΔY	[DZ]	ΔZ
[SX]	x	[SY]	y		
[DSX]	Δx	[DSY]	Δy		
[GU]	GU	[DGU]	ΔGU		
[DE]	ΔE^*ab	[CMC]	CMC	[DE94]	ΔE^*94
[DE00]	$\Delta E00$	[DEH]	ΔE (Hunter)	[MI]	MI
[WIE]	WI E313-73	[WIC]	WI CIE	[TINT]	Tint CIE
[DEWI]	ΔWI E313-73	[DWIC]	ΔWI CIE	[DTINT]	$\Delta Tint$ CIE
[YIE]	YI E313-73	[YID]	YI D1925	[BISO]	B(ISO)
[DYIE]	ΔYI E313-73	[DYID]	ΔYI D1925	[DBISO]	ΔB (ISO)

- GU and ΔGU can be used only with CM-26dG. UVfull+UVcut is available only with CM-26dG and 26d devices.

SCI variables

SCI values will be used even if the SCE screen is selected.

- Instrument Specular Component setting must include SCI.

Variable	Measurement value	Variable	Measurement value	Variable	Measurement value
[LI]	L*	[AI]	a*	[BI]	b*
[DLI]	ΔL^*	[DAI]	Δa^*	[DBI]	Δb^*
[CI]	C*	[HI]	H		
[DCI]	ΔC^*	[DHI]	ΔH^*		
[HLI]	L(Hunter)	[HAI]	a(Hunter)	[HBI]	b(Hunter)
[DHLI]	ΔL (Hunter)	[DHAI]	Δa (Hunter)	[DHBI]	Δb (Hunter)
[XI]	X	[YI]	Y	[ZI]	Z
[DXI]	ΔX	[DYI]	ΔY	[DZI]	ΔZ
[SXI]	x	[SYI]	y		
[DSXI]	Δx	[DSYI]	Δy		
[GUI]	GU	[DGUI]	ΔGU		
[DEI]	ΔE^*_{ab}	[CMCI]	CMC	[DE94I]	ΔE^*_{94}
[DE00I]	ΔE_{00}	[DEHI]	ΔE (Hunter)	[MII]	MI
[WIEI]	WI E313-73	[WICI]	WI CIE	[TINTI]	Tint CIE
[DEWII]	ΔWI E313-73	[DWICI]	ΔWI CIE	[DTINTI]	$\Delta Tint$ CIE
[YIEI]	YI E313-73	[YIDI]	YI D1925	[BISOI]	B(ISO)
[DYIEI]	ΔYI E313-73	[DYIDI]	ΔYI D1925	[DBISOI]	ΔB (ISO)

SCE variables

SCE values will be used even if the SCI screen is selected.

- instrument Specular Component setting must include SCE.

Variable	Measurement value	Variable	Measurement value	Variable	Measurement value
[LE]	L*	[AE]	a*	[BE]	b*
[DLE]	ΔL^*	[DAE]	Δa^*	[DBE]	Δb^*
[CE]	C*	[HE]	H		
[DCE]	ΔC^*	[DHE]	ΔH^*		
[HLE]	L(Hunter)	[HAE]	a(Hunter)	[HBE]	b(Hunter)
[DHLE]	ΔL (Hunter)	[DHAE]	Δa (Hunter)	[DHBE]	Δb (Hunter)
[XE]	X	[YE]	Y	[ZE]	Z
[DXE]	ΔX	[DYE]	ΔY	[DZE]	ΔZ
[SXE]	x	[SYE]	y		
[DSXE]	Δx	[DSYE]	Δy		
[GUE]	GU	[DGUE]	ΔGU		
[DEE]	ΔE^*ab	[CMCE]	CMC	[DE94E]	ΔE^*94
[DE00E]	$\Delta E00$	[DEHE]	ΔE (Hunter)	[MIE]	MI
[WIEE]	WI E313-73	[WICE]	WI CIE	[TINTE]	Tint CIE
[DEWIE]	ΔWI E313-73	[DWICE]	ΔWI CIE	[DTINTE]	$\Delta Tint$ CIE
[YIEE]	YI E313-73	[YIDE]	YI D1925	[BISOE]	B(ISO)
[DYIEE]	ΔYI E313-73	[DYIDE]	ΔYI D1925	[DBISOE]	ΔB (ISO)

UVfull+UVcut simultaneous measurement data

UVfull * UVfull values will also be used on the UVcut screen.

Variable	Measurement value	Variable	Measurement value	Variable	Measurement value
[LF]	L*	[AF]	a*	[BF]	b*
[DLF]	ΔL^*	[DAF]	Δa^*	[DBF]	Δb^*
[CF]	C*	[HF]	h		
[DCF]	ΔC^*	[DHF]	ΔH^*		
[HLF]	L(Hunter)	[HAF]	a(Hunter)	[HBF]	b(Hunter)
[DHLF]	ΔL (Hunter)	[DHAF]	Δa (Hunter)	[DHBF]	Δb (Hunter)
[XF]	X	[YF]	Y	[ZF]	Z
[DXF]	ΔX	[DYF]	ΔY	[DZF]	ΔZ
[SXF]	x	[SYF]	y		
[DSXF]	Δx	[DSYF]	Δy		
[DEF]	ΔE^*ab	[CMCF]	CMC	[DE94F]	ΔE^*94
[DE00F]	$\Delta E00$	[DEHF]	ΔE (Hunter)	[MIF]	MI
[WIEF]	WI E313-73	[WICF]	WI CIE	[TINTF]	Tint CIE
[DEWIF]	ΔWI E313-73	[DWICF]	ΔWI CIE	[DTINTF]	$\Delta Tint$ CIE
[YIEF]	YI E313-73	[YIDF]	YI D1925	[BISOF]	B(ISO)
[DYIEF]	ΔYI E313-73	[DYIDF]	ΔYI D1925	[DBISOF]	ΔB (ISO)

UVcut * UVcut values will also be used on the UVfull screen.

Variable	Measurement value	Variable	Measurement value	Variable	Measurement value
[LC]	L*	[AC]	a*	[BC]	b*
[DLC]	ΔL^*	[DAC]	Δa^*	[DBC]	Δb^*
[CC]	C*	[HC]	h		
[DCC]	ΔC^*	[DHC]	ΔH^*		
[HLC]	L(Hunter)	[HAC]	a(Hunter)	[HBC]	b(Hunter)
[DHLC]	ΔL (Hunter)	[DHAC]	Δa (Hunter)	[DHBC]	Δb (Hunter)
[XC]	X	[YC]	Y	[ZC]	Z
[DXC]	ΔX	[DYC]	ΔY	[DZC]	ΔZ
[SXC]	x	[SYC]	y		
[DSXC]	Δx	[DSYC]	Δy		
[DEC]	ΔE^*ab	[CMCC]	CMC	[DE94C]	ΔE^*94
[DE00C]	$\Delta E00$	[DEHC]	ΔE (Hunter)	[MIC]	MI
[WIEC]	WI E313-73	[WICC]	WI CIE	[TINTC]	Tint CIE
[DEWIC]	ΔWI E313-73	[DWICC]	ΔWI CIE	[DTINTC]	$\Delta Tint$ CIE
[YIEC]	YI E313-73	[YIDC]	YI D1925	[BISOC]	B(ISO)
[DYIEC]	ΔYI E313-73	[DYIDC]	ΔYI D1925	[DBISOC]	ΔB (ISO)

Example of User Equation results when using common, SCI only, and SCE only variables in SCI and SCE screens

	SCI screen	SCE screen
[L]	100	50
[L]+[LI]+[LE]	250 (= 100+100+50)	200 (=50+100+50)

Example of UVfull+UVcut simultaneous measurement data display results

	UV100	UV0
[L]	100	50
[L]+[LF]+[LC]	250 (= 100+100+50)	200 (=50+100+50)

Functions

Function string	Usage example	Explanation
+	A+B	= A + B
-	A-B	= A - B
*	A*B	= A × B
/	A/B	= A/B
POW	POW(A)	= A ²
SQRT	SQRT(A)	= \sqrt{A}
ABS	ABS(A)	= A (Absolute value of A)
SIN	SIN(A)	= sin A (where A is in degrees)
COS	COS(A)	= cos A (where A is in degrees)
TAN	TAN(A)	= tan A (where A is in degrees)
ASIN	ASIN(A)	= sin ⁻¹ A (where A is in degrees)
ACOS	ACOS(A)	= cos ⁻¹ A (where A is in degrees)
ATAN	ATAN(A)	= tan ⁻¹ A (where A is in degrees)
LOG	LOG(A)	= log A
LN	LN(A)	= ln A
EXP	EXP(A)	= e ^A
POW2	POW2(A,B)	= A ^B

User Class

The User Class classifies measurements according to the results of the User Equation having the same number (for example, UC1 classifies measurements according to the results of UE1).

Input Example

To classify measurements into 5 classes A, B, C, D, E based on the following conditions:

User Equation result	Class
$UE \geq 4$	A
$UE \geq 3$	B
$UE \geq 2$	C
$UE \geq 1$	D
$UE < 1$	E

the class definition would be:

CLASS(4, "A", 4, "B", 3, "C", 2, "D", 1, "E")

Input Format

CLASS(*n*, "*str1*", *d1*, "*str2*", *d2*, "*str3*", *d3*, ...)

where

<i>n</i>	Number of class thresholds (= number of classes - 1)
<i>str1</i>	Class label for class threshold 1. This label will be applied to UE values greater than class threshold 1.
<i>d1</i>	Class threshold 1
<i>str2</i>	Class label for class threshold 2. This label will be applied to UE values greater than class threshold 2 but less than class threshold 1.
<i>d2</i>	Class threshold 2
<i>str3</i>	Class label for class threshold 3. This label will be applied to UE values greater than class threshold 3 but less than class threshold 2.
<i>d3</i>	Class threshold 3
:	
:	

- *n* maximum value: 50
- Class label *str* maximum length: 6 characters
- Usable characters for class labels *str* are shown in the table on the following page.
- Class threshold *d* maximum length: 20 characters, but the number of significant digits used for calculations is 5.
- Classes should be input in order from classes with the largest threshold to the smallest threshold.
- Overall maximum length including "CLASS()": 200 characters
- If User Class will not be used, do not input a User Class definition.
- Class definition parameters are separated by commas ",".
- Period "." is used for the decimal point.

Usable characters for class labels

The following characters can be used.

- (sp) indicates a space.

	00	10	20	30	40	50	60	70
0			(sp)	0	@	P	`	p
1			!	1	A	Q	a	q
2			“	2	B	R	b	r
3			#	3	C	S	c	s
4			\$	4	D	T	d	t
5			%	5	E	U	e	u
6			&	6	F	V	f	v
7			'	7	G	W	g	w
8			(8	H	X	h	x
9)	9	I	Y	i	y
A			*	:	J	Z	j	z
B			+	;	K	[k	{
C			,	<	L	¥	l	
D			-	=	M]	m	}
E			.	>	N	^	n	
F			/	?	O	_	o	



KONICA MINOLTA