

# AIR FUSION IQ<sup>®</sup>

## OPERATOR'S MANUAL



STAHL'S  
**Hotronix**<sup>®</sup> 

**When using your heat press, basic precautions should always be followed, including the following:**

1. Read all instructions.
2. Use heat press only for its intended use.
3. To reduce the risk of electric shock, do not immerse the heat press in water or other liquids.
4. Never pull cord to disconnect from outlet, instead grasp plug and pull to disconnect.
5. Do not allow cord to touch hot surfaces, allow heat press to cool completely before storing.
6. Do not operate heat press with a damaged cord or if the equipment has been dropped or damaged. To reduce the risk of electric shock, do not disassemble or attempt to repair the heat press. Take it to a qualified service person for examination and repair. Incorrect assembly or repair could increase the risk of fire, electric shock, or injury to persons when the equipment is used. Power supply cord must be disconnected before cleaning or servicing press.
7. This appliance is not intended for use by persons (including children) with reduced physical, sensory or mental capabilities, or lack of experience and knowledge, unless they have been given supervision or instruction concerning use of the appliance by a person responsible for their safety.
8. Close supervision is necessary for any heat press being used by or near children. Do not leave equipment unattended while connected.
9. To avoid burns, do not touch hot metal parts or the heated platen during use.
10. To reduce the likelihood of circuit overload, do not operate other high voltage equipment on the same circuit.
11. If an extension cord is necessary, then a 20-ampere rated cord should be used. Cords rated for less ampere may overheat. Care should be taken to arrange the cord so that it cannot be pulled or tripped over.
12. Keep hands clear of the upper heat press platen during lock down as the pressure may cause injury.
13. Heat press should be placed on a sturdy, suitable stand at least 36"L x 24"W x 29"H.
14. Work area must be kept clean, tidy and free of obstructions.



# Table Of Contents



**Safety Instructions** 2

**Machine View** 4

**Operating Instructions** 5-7

Connecting the System 5

Start Up/Shut Down 5

Home Screen 6

Prepare to Print 7

**Touch Screen Guide** 8-11

Setup Menu 8

Password Setup 8

Preset Setup 9

Date & Time Setup 10

Display Setup 10

Auto On & Off Setup 10

System Setup 10

Calibration 11

Updating Software 11

**Connecting to the IQ® Portal** 12

**Electrical Schematic** 13

**Replacement Parts List** 14-15

**Contact** 16



# Operating Instructions

## Connecting the System

Insert power cord into IEC inlet located on the side of press (1.1).

Connect the power cord into a properly grounded electrical outlet with a sufficient amperage rating.

To remove a locking power cord (if equipped), depress the two red buttons while pulling on the plug (1.2).

### Voltage

**120 volt** presses require a full 15-amp grounded circuit.

**240 volt** presses require a full 10-amp grounded circuit.

### Extension Cords

If used, extension cords should be as short as possible and not less than 12 gauge. Heavy duty cords are recommended.

### Circuits

Circuits that have less than 15 amps, or have other high demand equipment or appliances (especially more than one heat press) plugged in, should not be used.

**Note:** If supply cord is damaged, it must be replaced by the manufacturer, its service agent, or a similarly qualified person to avoid hazard. Use SJT type rated 300 V cord for replacement.

## Start Up/Shut Down

To start up your heat press:

Flip the power switch ON (2.1). A splash screen displaying the Hotronix® logo and current software version is shown for several seconds.

To turn your heat press off, flip the power switch OFF.

To place your heat press into Standby Mode, touch and release the Power icon on the Home Screen (3.2 - following page). In Standby Mode, the heater turns off while the Touch Screen remains on, displaying an orange background as a warning if the platen is still hot (above 100°F / 38°C).

**NOTE:** Standby Mode must be used for the Auto On feature to function (10.1). The Auto On feature will not work if the power switch (2.1) is in the OFF position.

To start up your heat press while in Standby Mode, touch and release the Home icon on the Standby Screen.



1.1



1.2



2.1

### Home Screen

Displays the selected preset. Touch and hold to see application settings.

**NOTE:** Holding down material name will display targeted application settings. Screen displays current temperature, pressure, and time.

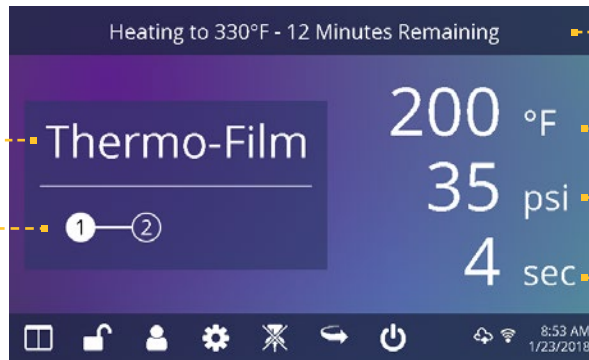

Status bar provides helpful information regarding heat press.

Displays the current application temperature, pressure and time.

3.1

Displays multiple heat application preset step. Touch the empty circled numbers to switch between preset steps.

Touch and edit your favorite presets.

Lock the screen (Manager-level only) to prevent User-level operators from changing settings.

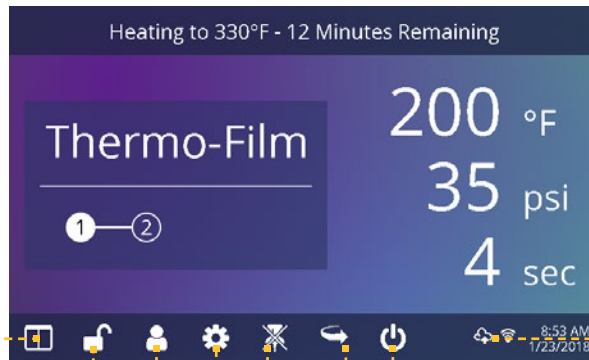

IQ® Portal and WIFI connection status.

3.2

Touch and edit Users to control operator access level and track press usage by operator in the IQ® Portal.

Touch Setup Menu.

Touch to cycle through Swing modes.

Place press in Standby Mode to take advantage of the scheduled Auto On feature.

Touch to toggle tack mode.

## Prepare to Print

To begin heat applying, start by verifying that you have the proper settings displayed on the Home Screen.

- Select preset material application.
- Manually enter temperature and time for selected material. Adjust pressure accordingly.

When desired settings are reached, you can begin heat application.

When using the Swing feature (4.1), swing the heat platen outward and position the garment and design.

Swing the platen back into position and press both print buttons to lower platen and heat apply (4.2).

The Home Screen will initiate a count down and signal when to lift the platen off the garment.

Swing or pull the heat platen and proceed according to the application instructions.



4.1



4.2



### Setup Menu

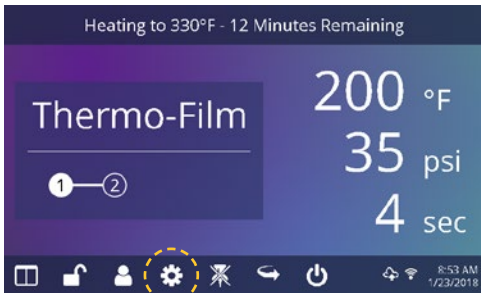

5.1

Touch the Settings icon on the Home Screen (5.1) to configure your heat press.

Managers can access all setup options, while Users can access a limited set (5.2).

- Managers default password: M



5.2

### Password Setup (Manager Level Only)

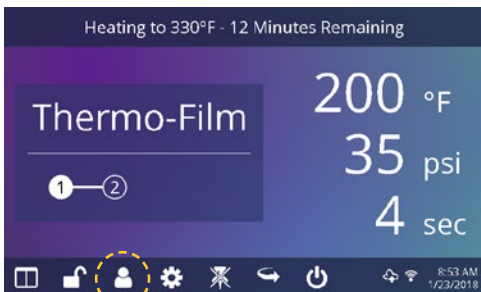

6.1

Touch the User icon on the Home Screen (6.1) or Setup Menu (6.2) to select, add, and edit Users.

Touch and edit Managers and Users to configure access to settings (6.3, 6.4). Heat press reports on the IQ® Portal can be filtered by User to track individual operator performance.

Touch the arrow keys on the taskbar to scroll through a long list of Users (6.5).



6.2

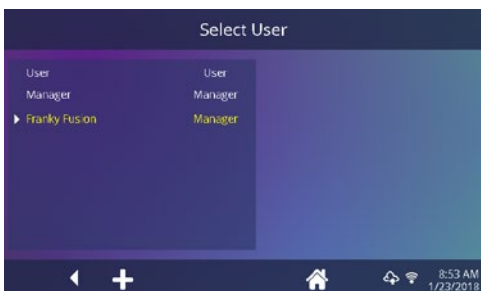

6.3

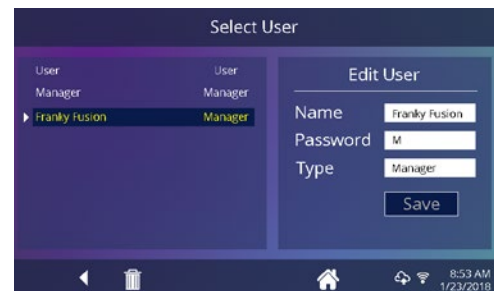

6.4

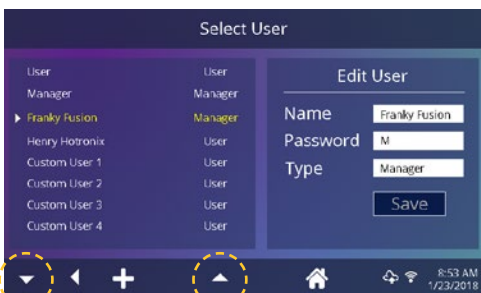

6.5



# Preset Setup

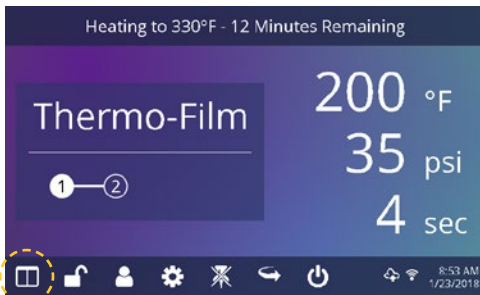

7.1

Touch the Columns icon (7.1) to select from a list of saved presets (7.2).

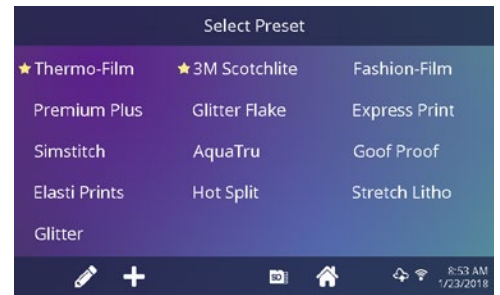

7.2

Touch the arrow keys on the taskbar to scroll through a long list of presets (7.3).

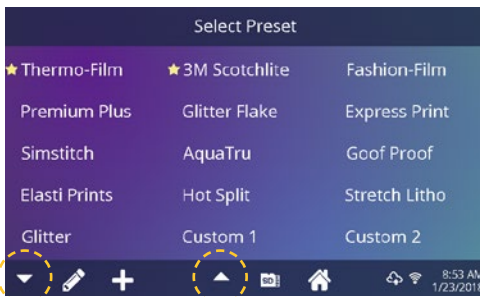

7.3

Touch a preset to select a material.

Touch the Pencil icon (7.4) to enter edit mode, then touch preset name to edit settings. Touch Save to save changes.

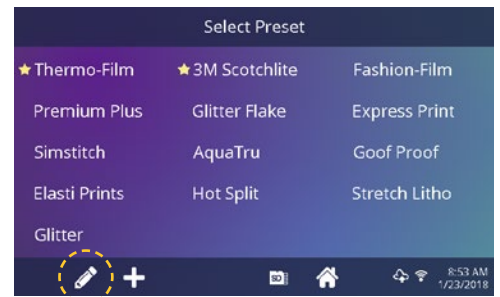

7.4

Touch the Plus icon to create a new preset (7.5).

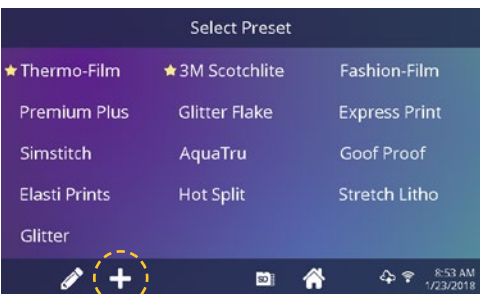

7.5

Name your preset and enter desired temperature, time, and pressure. When creating a new preset, the current Home Screen application settings are selected automatically (7.6).



7.6

Touch the empty circled numbers to set multiple preset stages for pretreatment or multi-step applications (7.7).



7.7

### Date & Time Setup

Touch the Settings icon on the Home Screen.

- Touch Date & Time, information displays on right of screen (8.1).
- Touch up/down arrows to select time zone.
- Touch Auto to automatically synchronize the heat press clock. The heat press must be connected to a WIFI network with access to the Internet.
- Touch Daylight Saving to enable daylight saving mode. This option should be enabled during summer.

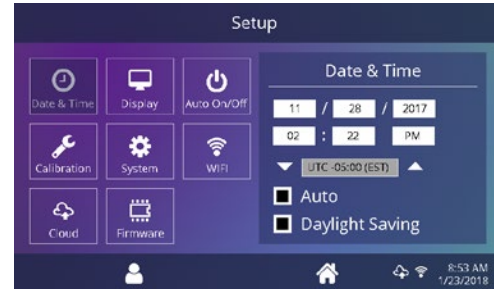

8.1

### Display Setup

Touch the Settings icon on the Home Screen.

- Touch Display, information displays on right of screen (9.1).
- Touch Temperature to switch between F° or C°, then touch Check Mark icon on taskbar to save.



9.1

### Auto On & Off Setup

Touch the Settings icon on the Home Screen.

- Touch Auto On/Off, information displays on right of screen (10.1).
- Touch Enable, then On Hour/Minute and Off Hour/Minute, selecting Enter between each setting. Once entered, touch Check Mark icon on taskbar to save.

**NOTE:** Standby Mode must be used for the Auto On feature to function (3.2).  
The Auto On feature will not work if the power switch (2.1) is in the OFF position.

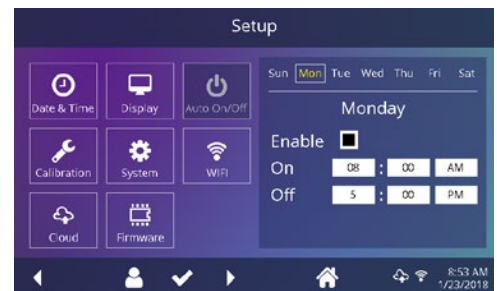

10.1

### System Setup (Manager Level Only)

Touch the Settings icon on the Home Screen.

- Select System, information displays on right of screen (11.1).
- Touch Power Save and select time, then touch Check Mark icon on taskbar to save.
- When enabled, your heat press will enter Standby Mode if it is not used for the specified number of hours.

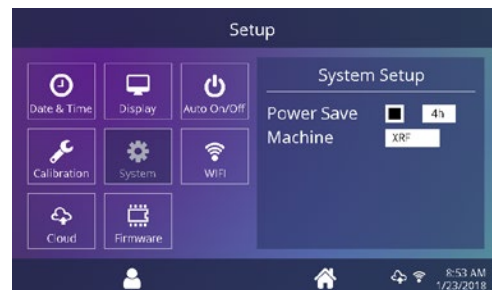

11.1

## Calibration (Manager-Level Only)

Your heat press comes pre-calibrated from the factory. Calibration is only required after sensor or controller replacement. Pressure is periodically self-calibrated. Incorrect calibration can result in poor print results or damage to your heat press which is not covered by warranty.

All FUSION® heat presses have a temperature calibration function (12.1).

- Turn on heat press and heat to 350°F/177°C.
- Place temperature strip on center of platen and press for 5 seconds, or measure center of heater with contact thermocouple (not infrared) thermometer.
- Touch the Settings icon on the Home Screen.
- Touch Calibration, information displays on right of screen.
- Touch Temperature and adjust Temperature Calibration to match Target Temperature.

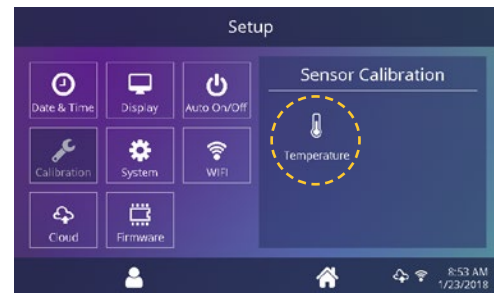

12.1

## Updating Software

Touch the Settings icon on the Home Screen.

- When a software update is available, an exclamation point appears after the version number in the Setup Menu (5.2).
- Touch Firmware, information displays on right of screen. An available online update displays a cloud icon (12.2).
- Touch Update File on right of screen, then touch Check Mark icon on taskbar to start download. A downloaded update displays a memory card icon.
- Touch Downloaded Update File on right of screen, then touch Check Mark icon on taskbar to start installation.

**NOTE:** If a power failure occurs during installation, the heat press will attempt to install the previous software version.

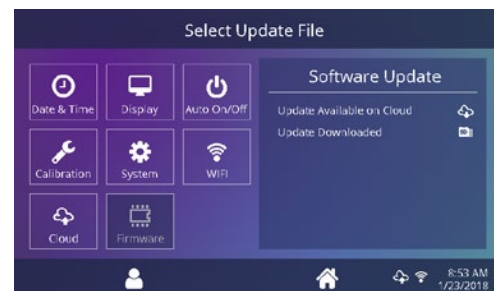

12.2



### Create Your Account

- Using a phone or computer, visit [iq.hotronix.com](http://iq.hotronix.com) to create an account (13.1).
- Enter your name, email, and password.
- Click on the confirmation link in the email you receive.
- Your account has been created.

### Register a Heat Press

- Click on Manage Heat Presses, then New Heat Press.
- Select heat press type, enter serial number, and enter a name for the heat press (optional).
- Click on Create Heat Press and enter the verification code given.
- On the heat press Setup Menu, touch WIFI and connect to your WIFI router or mobile hotspot (13.2).
- On the heat press Setup Menu, touch the Cloud icon and enter the verification code displayed in the IQ® Portal (13.3).
- Your heat press has been registered.

### Create & Assign Users

- Click on Manage Operators, then New User.
- Enter a name and select a privilege level. Managers can access all heat press settings while Users have limited access.
- Click on New User, then Assign Machines in the sidebar.
- Select a machine and click Assign.
- On the heat press Setup Menu, touch the Cloud icon, then Manual Sync (13.4).
- Reporting will show impressions made by the Users.

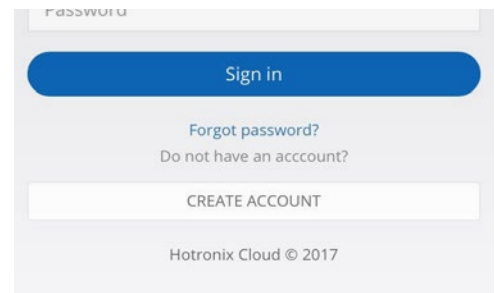

13.1



13.2

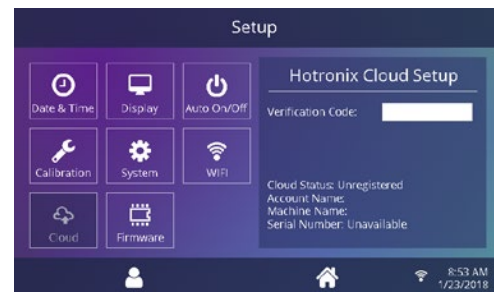

13.3

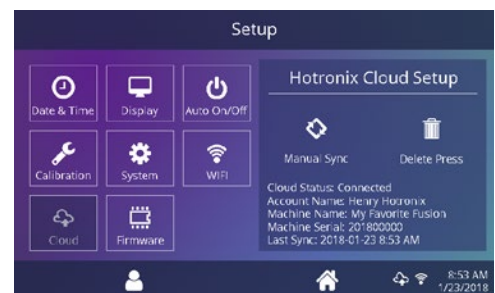

13.4

# Electrical Schematic

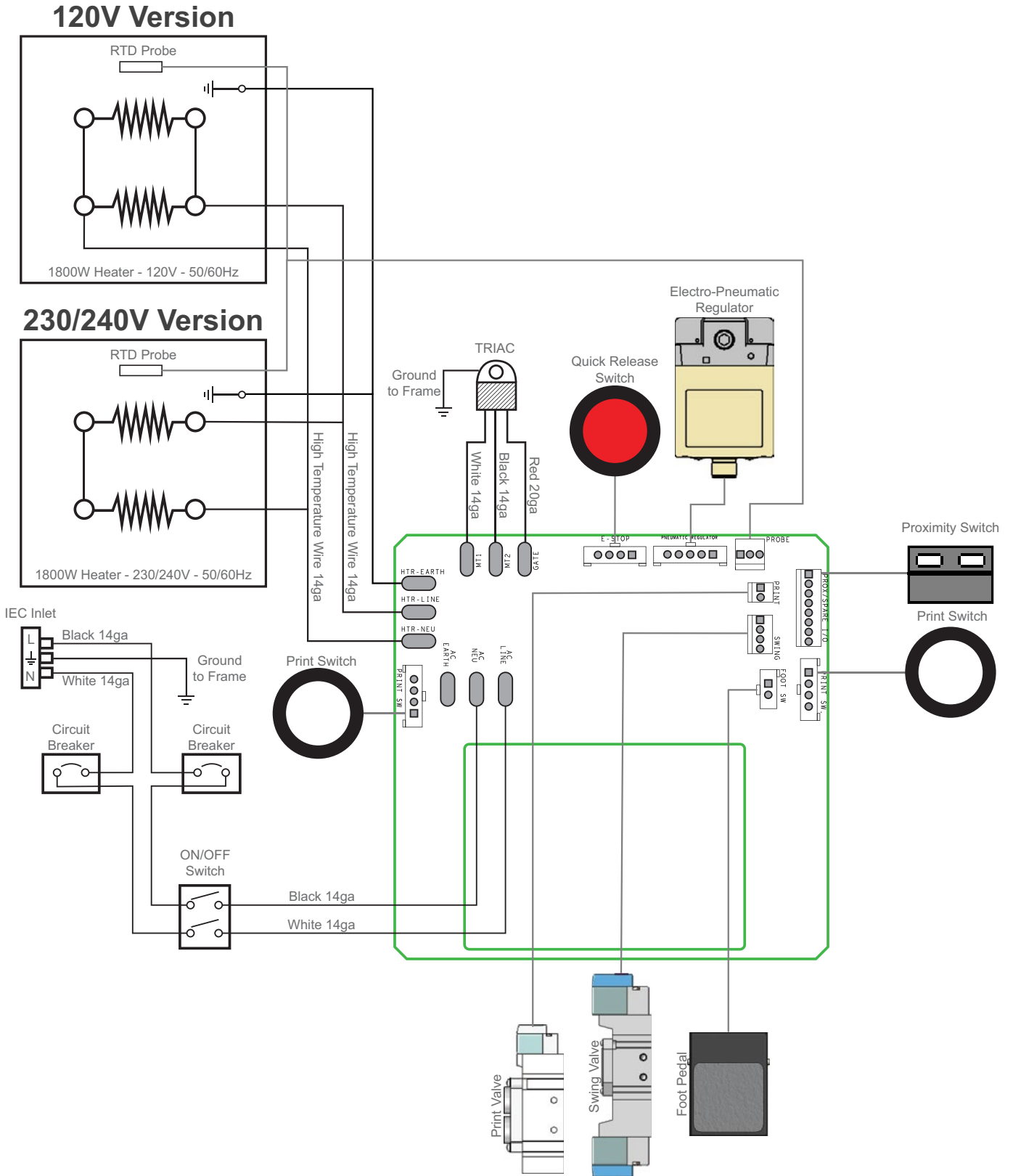

# HOTRONIX® AIR FUSION IQ®

## Replacement Parts List

ITEM #	PART NAME	PART #	QTY
1	Air Fusion Control Housing	1-2197	1
2	Cap, Plastic Black 1/2"	1-1971	2
3	Fusion IQ Power Board	—	1
4	Fusion IQ Power Bracket	1-2473	1
5	Screw, Sheet Metal #6 x 1/2"	3-1011-235	6
6	Fusion IQ Latch	1-2474	2
7	Spring, 1/4" x 1", 1.7lbs/in	—	2
8	Fusion IQ Controller	1-2463	1
9	Fusion Overlay NextGen	1-2198-1	1
10	Touchscreen Stylus Holder	1-2386	1
11	Touchscreen Stylus	1-2385	1
12	Button, White, Print Switch	1-2319	2
13	Button, Red, Quick Release	1-2270	1
14	Power Switch	1-2087	1
15	Chevron Cover Plate	1-2423	1
16	Screw, Machine #6-32 x 1/2"	3-1011-19	4
17	Nut, #6-32 Hex with Lockwasher	2-1006-50	3
18	Screw, Machine #8-32 x 3/4"	3-1011-155	3
19	Air Fusion Upper Casting	3-1341	1
20	Bearing, Tapered Cup	1-2268	2
21	TRIAC	1-1059	1
22	Bushing, Flange 1in	1-2282	1
23	Air Cylinder 6in	1-2264	1
24	Screw, Button Socket Head 5/16"-18 x 1"	3-1011-229	8
25	Nut, Hex 1"-12	2-1006-96	1
26	Washer, 1in Nord-Lock	2-1006-94	1
27	Air Fitting, Elbow 1/4" NPT x 1/4" Tube	4-1015-12	5
28	Air Fusion Shock Stop Plate	1-2302	1
30	Washer, 1/2" Nylon	1-1048-3	2
31		1-2308	1
32	Screw, Shoulder 1/2" x 1" w/ 3/8"-16 Thread	—	1
33	Bearing, 6900 Double Shielded	1-2280	1
34	Pin, Spring 3/8" D x 3/4" LG	1-1018-1	1
35	Shock Absorber	1-2300	1
36	Bearing, 1/2" Needle	1-2289	1
37	Screw, Machine #10-24 x 1/2"	3-1011-217	4
38	Washer, Plastic Finishing	1-1063	4
39	Air Fusion Heater Cover	1-2263	1
40	Insulation 16 x 20	1-1020	1
41	C-Clip	1-2286	1
42	Guide Tube, XRF & XRF2	1-2290	1
44	Screw, Socket Head 5/16"-18 x 3/4"	3-1011-100	1
45	Screw, Socket Head 3/8"-16 x 1"	3-1011-43	1
47	Screw, SS Phillips #8-32 X 1/4"	3-1011-87	1
48	Temperature Probe	1-1272-1	1
49	Thermostat Disc	1-2076	1
50	Screw, SS Sheet Metal #4 X 1/4"	3-1011-98	2
51	Heat Platen 16 x 20 1800W Milled (No Ears)	2-1002-3	1
52	Screw, Socket Head Cap Low Profile 1/4"-20 X 3/4"	3-1011-245	8
53	Screw, Machine #4-40 x 3/8"	3-1011-22	2
54	Nut, #4-40 with Tooth Washer	2-1006-51	2
55	Proximity Switch	1-1211	1
56	Chain 04B	1-2307	1
57	Sprocket, 22 Tooth 04B	1-2306	1
58	Pneumatic Package, Air Fusion	1-2269	1
61	Screw, Sheet Metal Hex #8 x 1/2"	1-2421	4
62	Screw, M4x0.7 x 8 Pan Phillips	1-2417	5
63	Print Valve	1-2299	1
64	Air Fitting, Straight Hex 1/4" NPT 1/4" Tube	1-2427	3

ITEM #	PART NAME	PART #	QTY
65	Air Fitting, Muffler, 1/8" NPT	1-2418	2
66	Speed Control Muffler	1-2339	1
67	Air Fitting, Check Valve, 1/4" Push-to-Connect	1-2419	1
68	Screw, Pan Phillips M3x05 x 6mm	—	2
69	Swing Valve	1-2298	1
70	Air Fitting, Elbow Restrictor #10-32 UNC 5/32" Tube	1-2428	2
71	Air Fitting, Elbow #10-32 UNF 5/32" Tube	1-2350	6
72	Electro-Pneumatic Regulator	1-2293	1
73	Air Fitting, Tee, 1/4" Push-to-Connect	1-2420	1
74	Pneumatic Regulator, Mini	1-2297	1
75	Air Fitting, Elbow #10-32 UNF 1/4" Tube	1-2430	1
76	Screw, Button Socket Head #10-32 x 1/2"	3-1011-164	6
77	Rotary Actuator	1-2296	1
78	Grommet, 5/16" ID 1/2" OD	1-2429	1
88	Air Tubing, 1/4" Polyurethane	1-1274	1
89	Air Fusion Bottom Casting	3-1340	1
90	Quick Release Clamp, Air Fusion	1-2332-1	1
91	Air Fusion Stop Plate	1-2284	1
92	Air Fusion Spindle	2-1670	1
94	Screw, Button Socket Head 5/16"-18 x 1-1/8"	—	8
95	Bearing, Tapered Roller Cone	1-2267	2
96	Spanner Nut 2in-18	2-1006-95	1
97	Bearing, 6002	1-2281	1
98	Sprocket, 32 Tooth 04B	1-2306-1	1
99	Air Fusion Proximity Magnet Bracket	—	1
100	Grommet, 3/8" ID 3/4" OD	1-2285	1
101	Proximity Magnet, Miniature	1-2311	1
102	Screw, Machine #4-40 x 1/4"	3-1011-15	2
103	Bearing Shield	1-2287	1
104	Air Fusion IO Panel, IEC Inlet	—	1
105	Circuit Breaker 20A (STX XF XRF)	1-1331	2
106	Power Inlet and Filter, 15A 120V	—	1*
106	Power Inlet and Filter, 20A 240V	1-2490	1*
107	Screw, Machine #6-32 x 1/4"	3-1011-25	4
108	Air Fusion IO Panel, Air Pedal and Breaker	—	1
109	Foot Pedal Socket (Part of Foot Pedal Assembly)	Kit 1-2305	1
110	Air Fitting, Elbow Bulkhead 1/4" Tube	—	1
111	Filter Regulator Bracket	—	1
112	Screw, Hex Head 1/4"-20 x 2"	3-1011-266	2
113	Nut, Hex 1/4"-20 Nylok	2-1006-7	2
114	Air Filter & Regulator	1-1215	1
115	Air Fitting, 1/4" ARO Male Coupling 1/4" NPT	1-1788	1
116	Sprocket Spacer	—	1
117	Magnet, Neodymium 0.50 x 0.25 w/ #4 Countersinks	—	1
118	Screw, Countersunk #6-32 x 3/8" Stainless	—	1
119	Platen, 16x20	2-1029	1
120	Silicone Pad 16 x 20 Blue	1-2136	1
121	Adapter Plate	3-1336	1
122	Quick Release Pin	1-2215	1
123	Washer, Flat 1/4" SAE	2-1006-25	4
124	Washer, Split Lock 1/4"	2-1006-44	4
125	Screw, Socket Head Cap 1/4"-20 x 1"	3-1011-191	4
127	Pedestal Stand Assembly	1-2291	1
143	Self-Leveling Stem Caster	1-2262	4
149	Nut, Hex 3/8"-16 Nylok	2-1006-10	4
150	Air Fusion Tabletop Stand	1-2324	1
151	Foot, Rubber Suction Cup with Stud, 5/16"-18	1-2329	4
152	Power Cord	—	1
154	Foot Pedal Assembly	Kit 1-2305	1

# Parts Location Guide

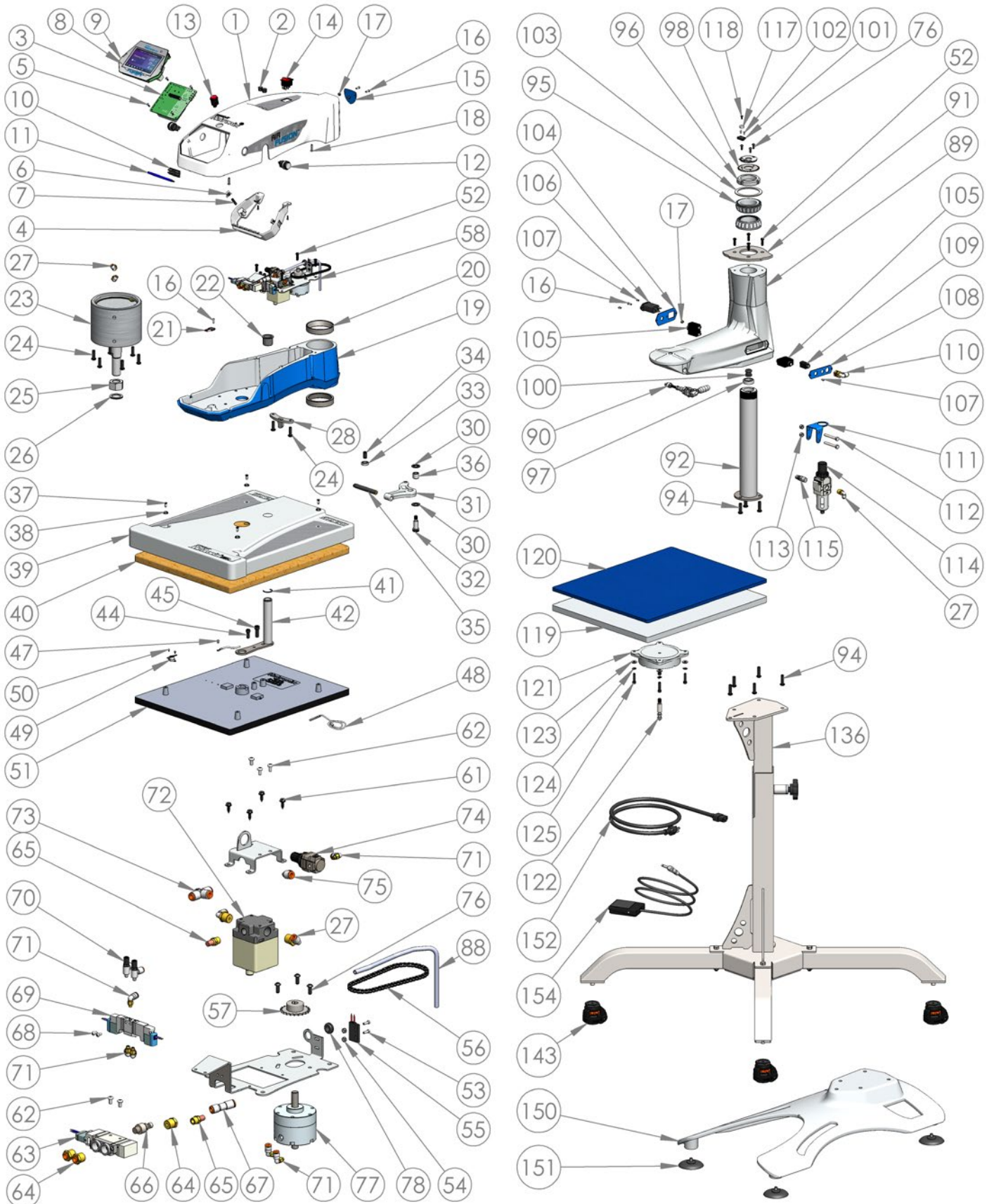

# CONTACT US

## **STAHL'S Hotronix®**

One Industrial Park  
Carmichaels, PA 15320  
U.S.A.

## **Technical Support**

[hotronix.com/support](http://hotronix.com/support)

## **Customer Service**

[customerservice@hotronix.com](mailto:customerservice@hotronix.com)

## **Replacement Parts**

800.727.8520

8AM - 7PM EST

## **Web**

[hotronix.com](http://hotronix.com)

